

MAGNA WWTP REUSE PRELIMINARY ENGINEERING REPORT AND REUSE PLAN

August 2021



Prepared for:



Prepared by:



BOWEN COLLINS
& ASSOCIATES

with



Stantec

MAGNA WWTP REUSE PRELIMINARY ENGINEERING REPORT AND REUSE PLAN

August 2021



Prepared for:



Prepared by:



with



TABLE OF CONTENTS

	Page No.
EXECUTIVE SUMMARY	ES-1
Introduction.....	ES-1
Secondary Irrigation Demand	ES-1
Water Quality	ES-2
Secondary Conveyance System	ES-3
Filtration Technology Evaluation	ES-3
Pump Station Evaluation.....	ES-4
Nutrient Management and Agronomic Uptake	ES-4
Operation and Management Plan	ES-5
Contingency Plan	ES-5
Public Notification.....	ES-6
Constructability Review.....	ES-6
Opinion of Probable Costs.....	ES-6
Funding Alternatives.....	ES-7
Implementation Schedule	ES-7
SECTION 1 – INTRODUCTION.....	1-1
1.1 Introduction	1-1
1.2 Background.....	1-2
1.3 Acknowledgements	1-2
1.4 Project Staff	1-3
SECTION 2 – NEED FOR SECONDARY WATER	2-1
2.1 Introduction	2-1
2.2 Secondary Irrigation Demand.....	2-1
2.2.1 Need for Secondary Water	2-1
2.2.2 Peak Reuse Demand.....	2-3
2.2.3 Seasonal Reuse Demand.....	2-4
2.2.4 Other Reuse Opportunities	2-7
2.3 Water Quality.....	2-7
2.3.1 Historical Flow	2-7
2.3.2 Water Quality Requirements.....	2-8
2.3.3 Historical Effluent Water Quality	2-9
2.4 Secondary Conveyance Systems	2-12
2.4.1 Planned Improvements	2-12
2.4.2 Modeling Approach	2-13
2.4.3 Modeling Results	2-14
2.5 Conclusions and Recommendations	2-17
SECTION 3 – REUSE FACILITY EVALUATION	3-1
3.1 Introduction	3-1
3.2 Reuse Facilities Overview.....	3-1
3.3 Filtration Technology Evaluation.....	3-1
3.3.1 Cloth Media Filtration Basics	3-2

**TABLE OF CONTENTS
(continued)**

	Page No.
3.3.2 Cloth Media Filtration Basics	3-2
3.3.3 Vendor Proposal Criteria	3-4
3.3.4 Generalized Filter Layout	3-6
3.3.5 Reliability and Redundancy	3-11
3.3.6 Proposal Summary and Analysis	3-12
3.3.7 Equipment Cost Summary.....	3-14
3.3.8 Discussion and Recommendations	3-16
3.4 Disinfection Modifications.....	3-16
3.4.1 Concept.....	3-16
3.4.2 Existing Facilities	3-17
3.4.3 Discussion and Recommendations	3-19
3.5 Pump Station Evaluation.....	3-19
3.5.1 Pump Station Elevation Assumptions	3-19
3.5.2 Hydraulic Analysis.....	3-19
3.5.3 Pump Type Evaluation.....	3-20
3.5.4 Phasing and Redundancy Requirements.....	3-21
3.5.5 Pump Station Horsepower Requirements.....	3-22
3.5.6 Wet Well Sizing	3-23
3.5.7 Conceptual Pump Station Layout	3-24
3.6 Hydraulic Review and Conceptual Site Layout.....	3-24
3.6.1 Hydraulic Profile Development.....	3-24
3.6.2 Hydraulic Controls and Emergency Diversion.....	3-24
3.6.3 Model Methodology.....	3-26
3.6.4 Hydraulic Model Results	3-26
3.6.5 Conceptual Site Layout	3-27
3.7 Conclusions and Recommendations	3-27
SECTION 4 – REUSE PLAN SUPPLEMENTAL DOCUMENTATION	4-1
4.1 Introduction	4-1
4.2 Nutrient Management and Agronomic Uptake.....	4-1
4.2.1 Agronomic Nutrient Requirement	4-1
4.2.2 Irrigation Water Requirements.....	4-3
4.2.3 Application Limitations	4-4
4.3 Operation and Management Plan	4-5
4.4 Contingency Plan.....	4-5
4.5 Public Notification	4-6
4.6 Conclusions and Recommendations	4-6
SECTION 5 –IMPLEMENTATION PLAN	5-1
5.1 Constructability Review	5-1
5.2 Electrical Capacity Evaluation	5-1
5.3 Opinion of Probable Costs	5-3
5.4 Funding Alternatives	5-4
5.5 Implementation Schedule.....	5-5

**TABLE OF CONTENTS
(continued)**

	Page No.
5.6 Conclusions and Recommendations	5-5

LIST OF APPENDICES

- APPENDIX A – GLOSSARY OF ABBREVIATIONS
- APPENDIX B – SECONDARY WATER ALTERNATIVES REPORT
- APPENDIX C - MANUFACTURER PROPOSALS
- APPENDIX D - HYDRAULIC PROFILE FROM 1985 DRAWINGS
- APPENDIX E - APPROVED WATER RIGHT
- APPENDIX F - WATER SMART GRANT AWARD LETTER
- APPENDIX G - SUMMARY OF AMERICAN RESCUE PLAN ACT
- APPENDIX H - DISCHARGE PERMIT WITH VARIANCE REQUIREMENTS

**TABLE OF CONTENTS
(continued)**

LIST OF TABLES

No.	Title	Page No.
ES-1	Peak Secondary Demand vs Available Wastewater	ES-2
ES-2	Utah Type I Requirements	ES-3
ES-3	Reuse Facility Opinion of Probable Cost	ES-7
ES-4	MWD Reuse Facility Implementation Schedule	ES-8
2-1	Peak Secondary Demand vs Available Wastewater	2-3
2-2	Portion of Available Reuse Water Used for Secondary Irrigation	2-6
2-3	Adjusted Annual Average and Maximum Month Effluent Flow (Brine Diverted)	2-8
2-4	Utah Type I Requirements	2-9
2-5	2019-2020 Effluent Water Quality, Before and After Brine Diversion	2-10
3-1	Cloth Media Filtration Performance Requirements	3-2
3-2	Cloth Media Filter Technologies and Proposals Solicited	3-4
3-3	Cloth Media Filter Vendor Proposal Criteria	3-5
3-4	No. Discs Required per Train by Filter Vendor and Configuration	3-12
3-5	Proposal Comparison for Option 1: 2+0 Configuration	3-12
3-6	Proposal Comparison for Option 2: 1+1 Configuration	3-13
3-7	Proposal Comparison for Common Features	3-14
3-8	Filter Cell Sizing by Configuration	3-15
3-9	Reuse Pump Station Horsepower Requirements	3-23
3-10	Wet Well Sizing Options	3-23
3-11	Filter Influent Control Options	3-25
3-12	Conceptual Flow Split by Design Filter Influent Water Surface Elevation	3-27
4-1	Magna WWTP Nitrogen Fractions in Effluent	4-2
4-2	Magna WWTP Effluent Nitrogen Quantities	4-3
5-1	Electrical Power Requirements	5-2
5-2	Reuse Facility Opinion of Probable Cost	5-3
5-3	MWD Reuse Facility Implementation Schedule	5-5

**TABLE OF CONTENTS
(continued)**

LIST OF FIGURES

No.	Title	On or Following Page No.
ES-1	Service Area with Potential Annexation Areas.....	ES-1
ES-2	Secondary Water Production Requirements	ES-1
ES-3	Filter Building – Plan and Section.....	ES-4
ES-4	Filter Building and Pump Station.....	ES-4
ES-5	Filter Building and Pump Station.....	ES-4
ES-6	Conceptual Site Plan.....	ES-4
ES-7	Effluent Land Application Limits.....	ES-5
1-1	Service Area with Potential Annexation Areas.....	1-1
2-1	Secondary Water Production Requirements	2-2
2-2	Secondary Water Capacity Requirements.....	2-2
2-3	Peak Secondary Demand vs. Available Wastewater	2-4
2-4	2020 Secondary Irrigation Demand by Month.....	2-5
2-5	2040 Secondary Irrigation Demand by Month.....	2-5
2-6	2060 Secondary Irrigation Demand by Month.....	2-6
2-7	2019-2020 Average Daily Effluent Flow.....	2-8
2-8	2019-2020 Effluent Total Suspended Solids.....	2-11
2-9	2019-2020 Effluent E-Coli	2-12
2-10	2060 Secondary Pipe Improvement Project Numbers	2-12
2-11	Expected System Curve for Reuse Pump Station – 2020 Conditions	2-14
2-12	Expected System Curve for Reuse Pump Station – 2040 Conditions	2-15
2-13	Expected System Curve for Reuse Pump Station – 2060 Conditions	2-16
2-14	2020, 2040, 2060 System Curves.....	2-17
3-1	Reuse Process Schematic.....	3-1
3-2	Typical Disc Filter.....	3-3
3-3	Aqua-Aerobic: Representative Filter Configuration	3-7
3-4	Evoqua: Representative Filter Configuration	3-8
3-5	Five Star Filtration: Representative Filter Configuration	3-9
3-6	Nexom: Representative Filter Configuration	3-10
3-7	Filter Building – Plan and Section.....	3-11
3-8	Equipment Budgetary Costs by Vendor and Configuration	3-15
3-9	Disinfection Concept	3-17
3-10	Chlorine Contact Basin	3-17
3-11	Chlorinator, Storage Tanks, and Scale.....	3-18
3-12	Existing Unused Chlorine Feed	3-18
3-13	2020, 2040, and 2060 Reuse Pump Station System Curves.....	3-20
3-14	2040 Pump Operating Ranges.....	3-22

**TABLE OF CONTENTS
(continued)**

LIST OF FIGURES

No.	Title	On or Following Page No.
3-15	Pump Station – Plan and Section.....	3-24
3-16	Hydraulic Summary.....	3-27
3-17	Conceptual Site Plan for the Reuse Pump Station.....	3-27
3-18	Filter Building and Pump Station.....	3-28
3-19	Filter Building and Pump Station.....	3-28
4-1	Recommended Watering Rate for Turf Grass.....	4-4
4-2	Effluent Land Application Limitations.....	4-4

EXECUTIVE SUMMARY

INTRODUCTION

The Magna Water District (MWD or District) provides water and sewer services to the Township of Magna, Utah as well as small portions of West Valley City, Utah and Salt Lake City, Utah. Figure ES-1 identifies the District service area. MWD is committed to serving the current and future water needs within their service area. To that end, MWD recently completed the 2020 Water and Sewer Master Plans. Both of these reports identify Secondary Reuse as a priority for the District. The District contracted with Bowen Collins & Associates (BC&A) to provide engineering services for preliminary evaluation and final design of the 2021 Secondary Reuse Project which will meet the objectives identified in the Master Plans.

This report documents the preliminary evaluation, establishes the basis of final design for the 2021 Secondary Reuse Project, and also serves as the Secondary Effluent Reuse Plan to be submitted to the Utah Division of Water Quality (UDWQ) as required by Utah Rule 317.

SECONDARY IRRIGATION DEMAND

Both of the master plans identified the Secondary Reuse project as a priority for the District. In the case of the Sewer Master Plan, the reuse project is an important component of the District’s plans to meet nutrient removal requirements. Regarding water, the reuse project is a fundamental part of the District’s future water supply. As shown in Figure ES-2, the District’s projected need for supply on an annual basis (including a recommended buffer for supply reliability and redundancy) is expected to exceed existing supply by 2022.

**Figure ES-2
Secondary Water Production Requirements**

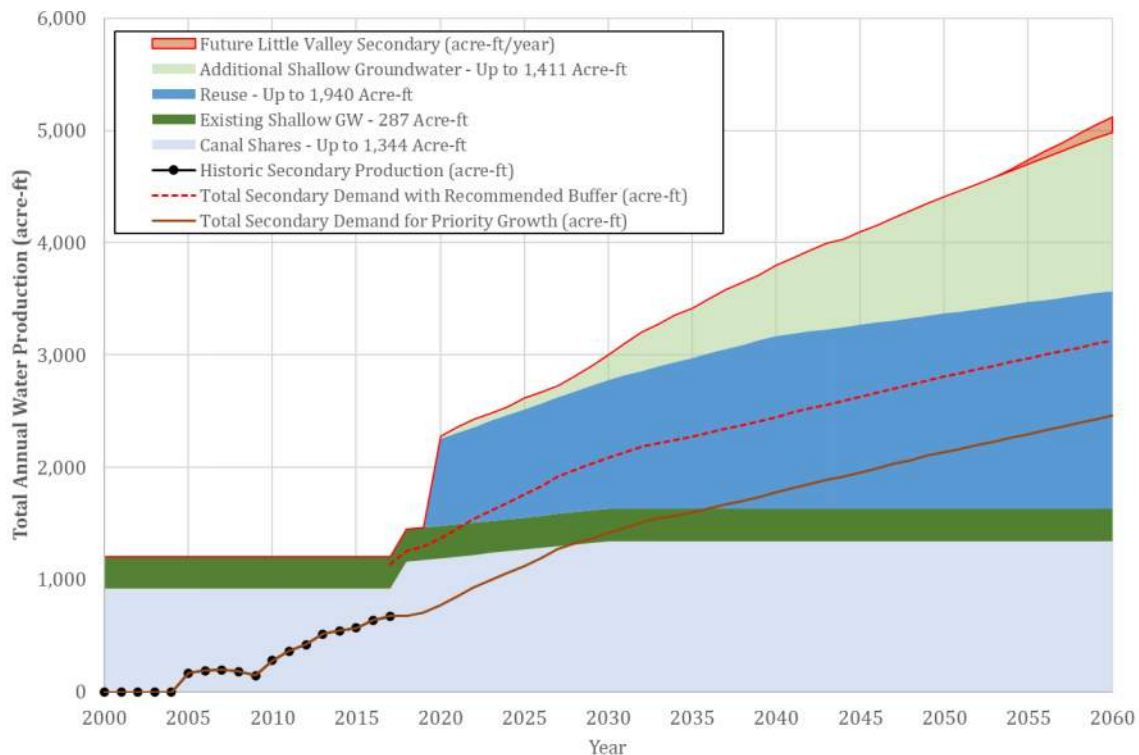

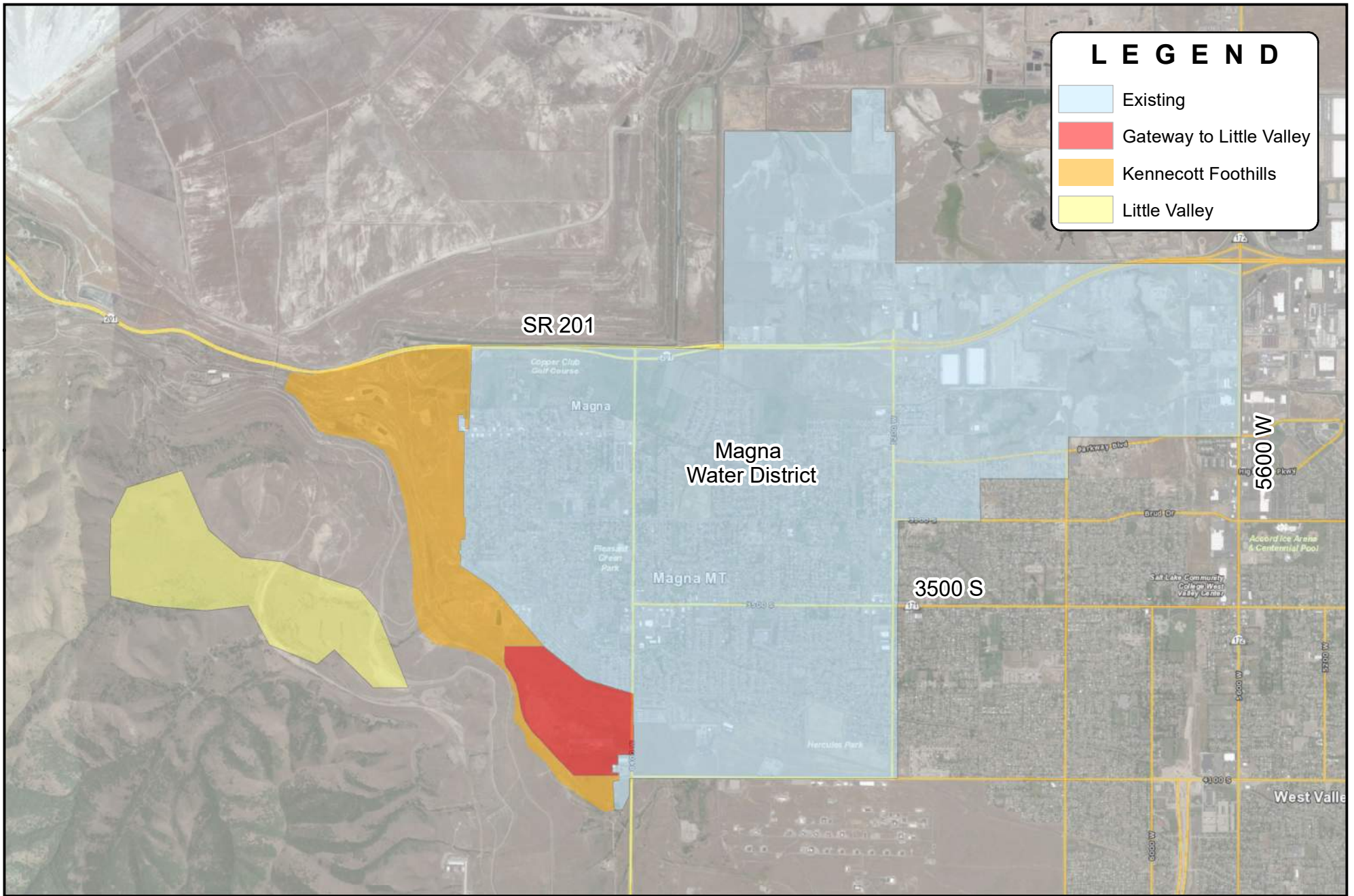

LEGEND

- Existing
- Gateway to Little Valley
- Kennecott Foothills
- Little Valley



MAGNA WATER DISTRICT
**REUSE PROJECTS
 PRELIMINARY ENGINEERING
 REPORT**

**SERVICE AREA
 WITH POTENTIAL
 ANNEXATION AREAS**

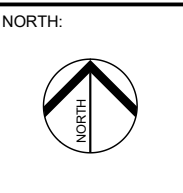

SCALE:
 0 2,000 4,000

 Feet

FIGURE NO.
ES-1

Once reuse water is available, it is expected to become the District's preferred water source in the secondary system. This is a result of overall better water quality compared to other sources and the benefits it provides in meeting nutrient removal requirements for discharge into the C7 Ditch. As a result, use of secondary water for irrigation is expected to be equal to either the demand in the irrigation system or the maximum amount of wastewater available to treat. Thus, the peak demand for reuse water (for irrigation purposes) can be projected by examining peak irrigation demand compared to available wastewater flow. Available wastewater flow is based on projections developed in the District's most recent sewer master plan. Flows are also summarized in Table ES-1.

Table ES-1
Peak Secondary Demand vs Available Wastewater

Year	Secondary Irrigation Demand (mgd)	Average Annual Wastewater Flow (mgd)
2020	2.35	2.61
2025	3.41	3.00
2030	4.30	3.30
2035	4.87	3.50
2040	5.40	3.71
2045	5.94	3.92
2050	6.49	4.09
2055	6.98	4.26
2060	7.47	4.43

WATER QUALITY

Water quality requirements for use of treated effluent within secondary irrigation systems (Type I Reuse) is governed by Utah Administrative Code R317-3. Water quality requirements for Type I reuse is summarized in Table ES-2.

**Table ES-2
Utah Type I Requirements**

Parameter	Notes	Unit	Type I	Notes
BOD	Monthly arithmetic mean; 24 hr composite; n=6	mg/L	10	1
Turbidity	Daily arithmetic mean	NTU	2	2
	Maximum instantaneous	NTU	5	2
E-Coli	Weekly median	#/100 mL	ND	2
	Maximum daily grab	#/100 mL	9	
Residual Chlorine	Continuously measured	mg/L	1	3
pH	Daily grab samples or continuous monitoring	SU	6 to 9	

1. Monthly Reports provide daily grab samples. Revisit sampling methodology and frequency for reuse design basis.
2. Data not available. Revisit sampling methodology and frequency for reuse design basis, as needed.
3. Data continuously below requirement; this will be addressed under Task 3 for potential disinfection improvements and operational practices.

The following sections identify improvements necessary so that effluent from the Magna WWTP will meet the Type I water quality requirements, as well as system improvements necessary to distribute the reuse water throughout the secondary irrigation system.

SECONDARY CONVEYANCE SYSTEM

The District's secondary conveyance system hydraulic model was used to analyze the existing system's ability to distribute the reuse water. Existing conditions scenario (year 2020), a 20-year conditions scenario (year 2040), and a 40-year conditions scenario (year 2060, considered to be build out) were included in the evaluation. The goal of this modeling effort was to determine the system curves needed at the reuse pump station for these three scenarios and the timing of secondary conveyance system improvements needed from the perspective of reuse water delivery.

The District will only need to construct Project SD-12 (currently under construction) to initially connect the reuse project with the rest of the existing secondary water conveyance system. Once the reuse production grows to 3.0 mgd (projected to be around 2027), Projects SD-1 and SD-2 are needed. These projects are further described in the 2020 Master Plan.

FILTRATION TECHNOLOGY EVALUATION

Based on previous reports and evaluations completed for the District (refer to the Secondary Water Alternatives Report dated June 2020 in the appendices), tertiary cloth media disc filtration was selected as the best option to treat secondary effluent for irrigation and agricultural reuse purposes. Cloth media disc filtration is an effective filter technology, particularly in reuse applications. Water enters the filter tank by flowing over an influent weir where it partially or completely submerges the filter discs (depending on manufacturer's layout). Water is treated through the disc filter from either an outside-in or an inside-out flow path, depending on the manufacturer. Solids accumulate on the cloth media and the treated water flows out of the discs to an effluent channel.

Proposals were solicited from four of the leading disc filter manufacturers that have a history of installations and technical expertise for this application. While evaluating the four solicited manufacturers, it was determined that although there are variances in the various technologies, largely driven by filter disc diameter, recommended loading rates, and proposed piping configurations, there was enough commonality that three of the four technologies (all using an outside-in flow pattern) would fit into a common butterfly configuration. This configuration also

closely matched preliminary layout and footprint requirements for the reuse pumping station. Accordingly, for the purposes of this study, a generalized filter model using the outside-in flow pattern was developed to facilitate conceptual site planning and hydraulic evaluation.

The fourth technology, manufactured by Evoqua, has an inside-out flow path and a much larger and shallower footprint by comparison. Evoqua was not further evaluated in this memorandum. At this time, we are not recommending that inside-out technologies be excluded from consideration, but recommend during preliminary design and equipment preselection that the capital cost of a larger footprint and shallower filter cell be considered concurrent with the technology. The generalized filter model is displayed in Figure ES-3.

It is recommended that the filters be installed in concrete basins to ensure gravity flow compatibility with the existing plant hydraulic profile. It is also recommended that a filter preselection be performed during preliminary design phase to allow for manufacturer specific efficiencies in sizing and layout configuration.

PUMP STATION EVALUATION

Based on the required flow and head for this pump station, it was determined that vertical turbine pumps would be best suited for the District's reuse pump station. Vertical turbine pumps are recommended for this application due to their high efficiencies, reliability, and ease of maintenance. This pump station is proposed to have a wet well installed under the pump station building to provide a minimum of 30-minutes of operation storage at peak flows between the filter and the pumps.

Vertical turbine pumps will allow for the motor and pump controls to be in a dry, at-grade pump station building with the pump column and bowls extending into the wet well below. This allows for direct pumping from the wet well and avoids suction piping. It is recommended that the pumps in this reuse pump station be equipped with variable frequency drives (VFDs). VFDs will maximize operational flexibility needed to adjust to seasonal fluctuation of reuse water demands and assist in maximizing reuse of WWTP effluent in the secondary system.

The pump station is recommended to be equipped with four total pumps. Three identically sized, 200 HP pumps would operate for most of the irrigation season, with two pumps on duty and one in standby (2+1). This provides for 50% pumping redundancy at peak flow. A smaller jockey pump (60 HP) is recommended to pump during times when irrigation demands are much lower in the early spring and late fall. The use of the one smaller pump in low demand portions of the season will prevent excessive cycling of the larger pumps, wet well and filters outside of peak irrigation season. Figures ES-4 through ES-6 illustrate a conceptual layout and section for the Magna Reuse Facility.

NUTRIENT MANAGEMENT AND AGRONOMIC UPTAKE

A comparison of water quantities applied based on nutrient requirements versus water requirements is shown in Figure ES-7. As illustrated, nearly 2.5 times the amount of water needed would have to be applied to meet the nutrient requirements of the turf grass, thus the volume of water needed to meet the watering requirement will be the controlling factor when determining the acreage that can be irrigated with the Magna WWTP effluent.

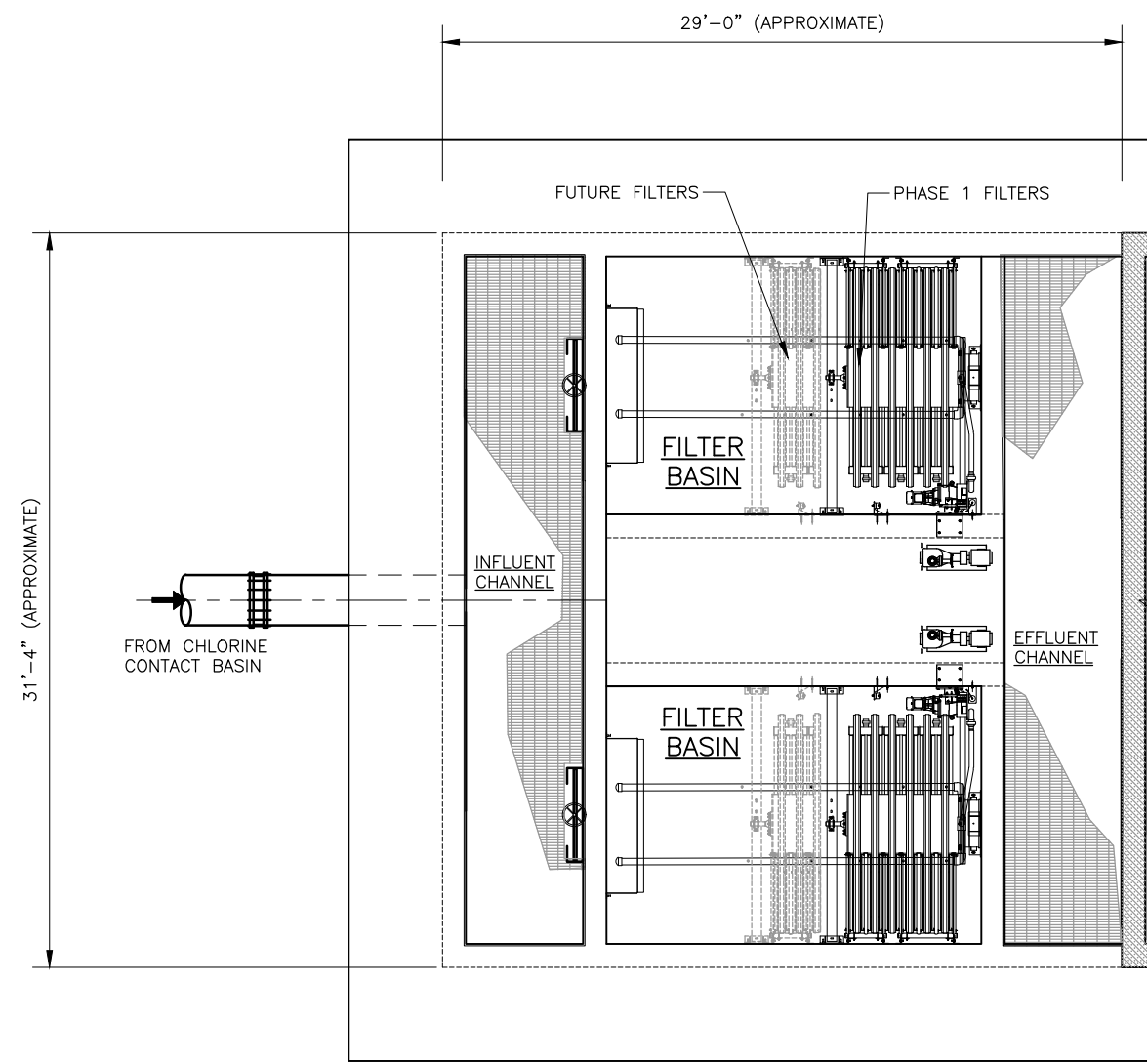

FILTER BUILDING – PLAN
SCALE: 1/4"=1'-0"

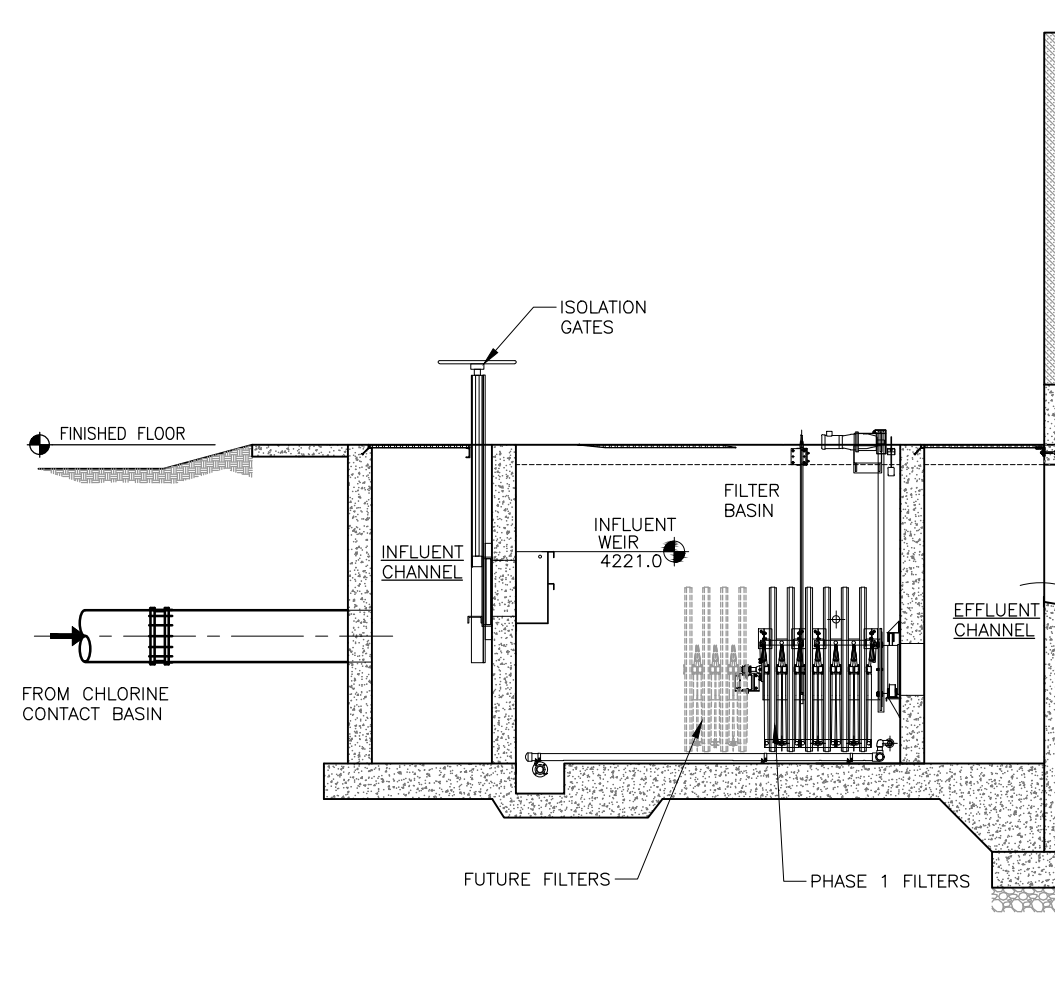

SECTION
SCALE: 1/4"=1'-0"

NOTES:

1. THIS DRAWING PROVIDES A CONCEPTUAL LAYOUT. FINAL DIMENSIONS AND LAYOUT WILL BE DETERMINE DURING FINAL DESIGN AND UPON SELECTION OF SPECIFIC MANUFACTURER.
2. BUILDING ENCLOSURE TO BE EVALUATED DURING FINAL DESIGN.



MAGNA WATER DISTRICT
REUSE PROJECT PRELIMINARY ENGINEERING REPORT
FILTER BUILDING - PLAN AND SECTION
FIGURE ES-3

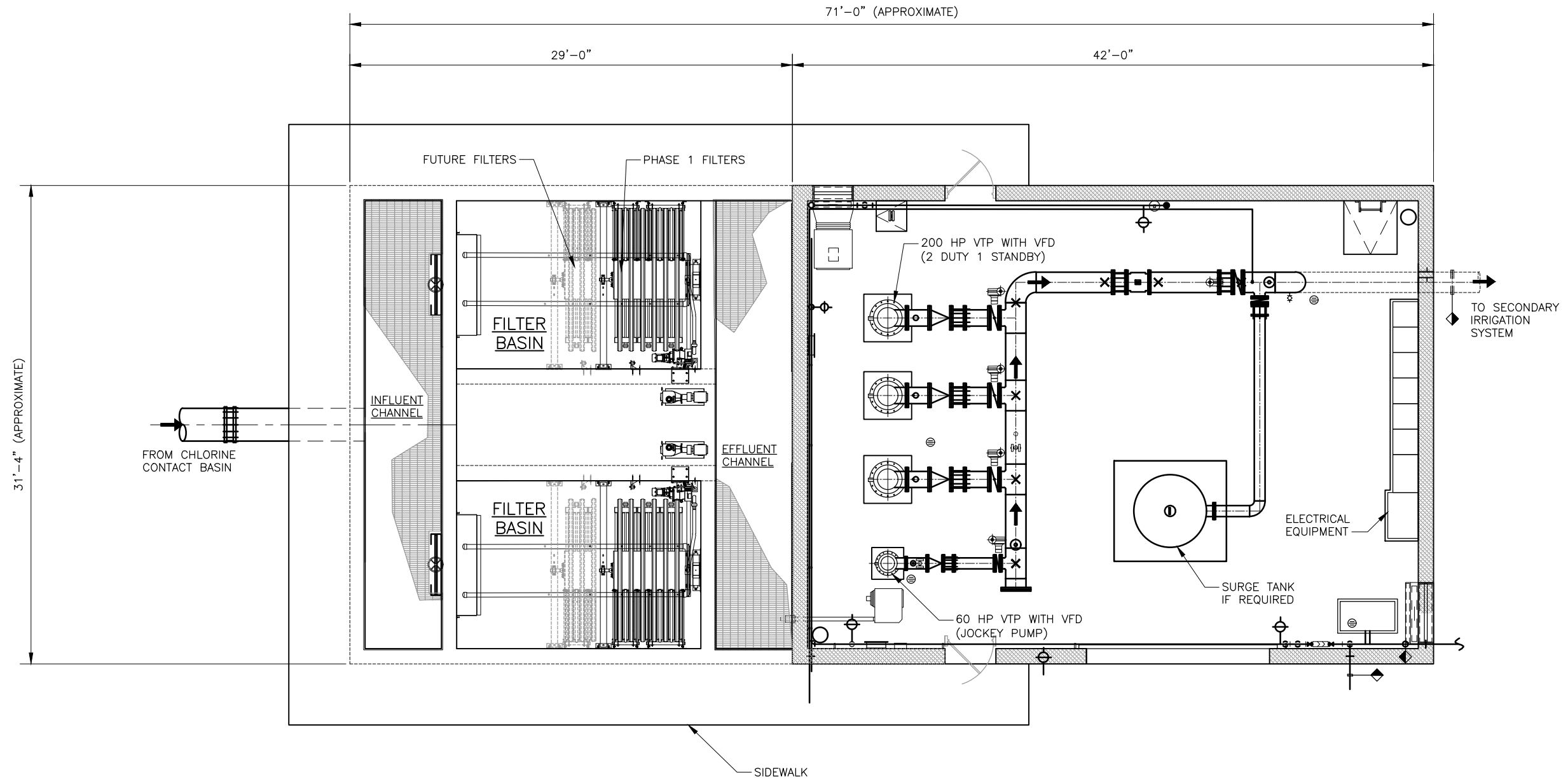

FILTER BUILDING AND PUMP STATION – PLAN
 SCALE: 1/4"=1'-0"



MAGNA WATER DISTRICT
 REUSE PROJECT PRELIMINARY ENGINEERING REPORT
FILTER BUILDING AND PUMP STATION
 FIGURE ES-4

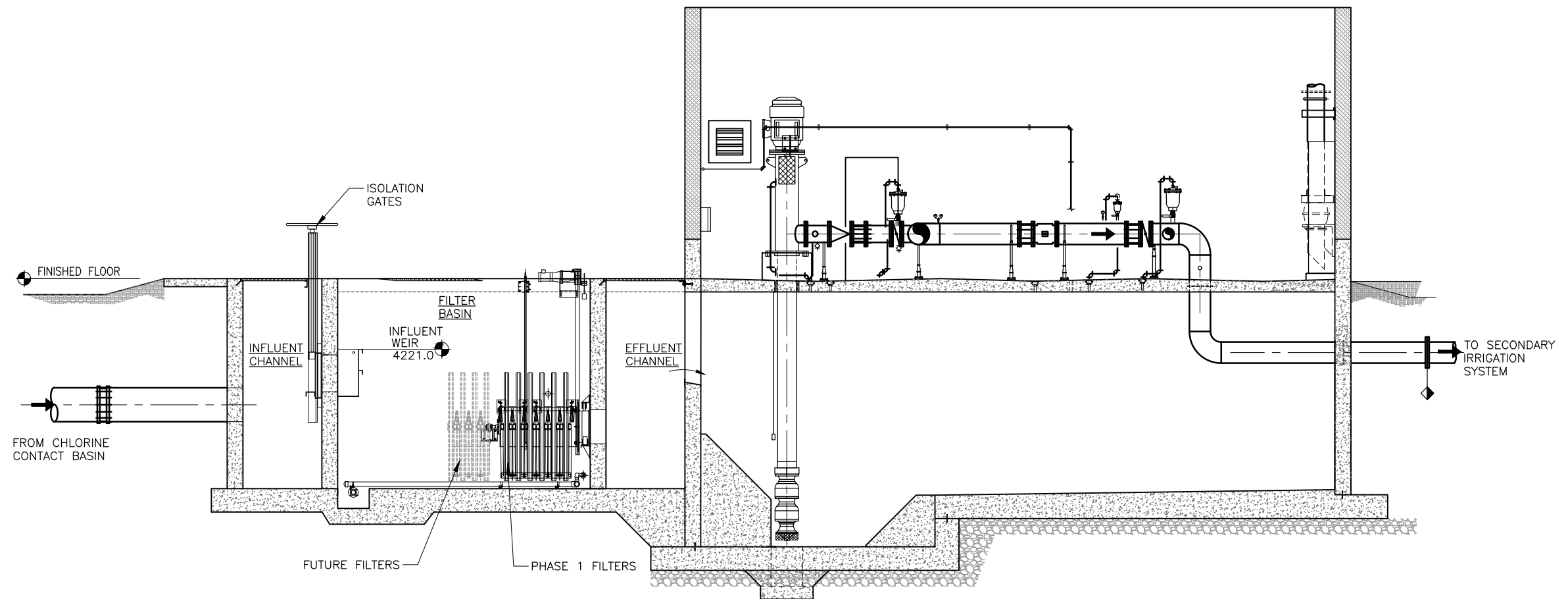

FILTER BUILDING AND PUMP STATION – SECTION
 SCALE: 1/4" = 1'-0"



MAGNA WATER DISTRICT
 REUSE PROJECT PRELIMINARY ENGINEERING REPORT
FILTER BUILDING AND PUMP STATION
 FIGURE ES-5

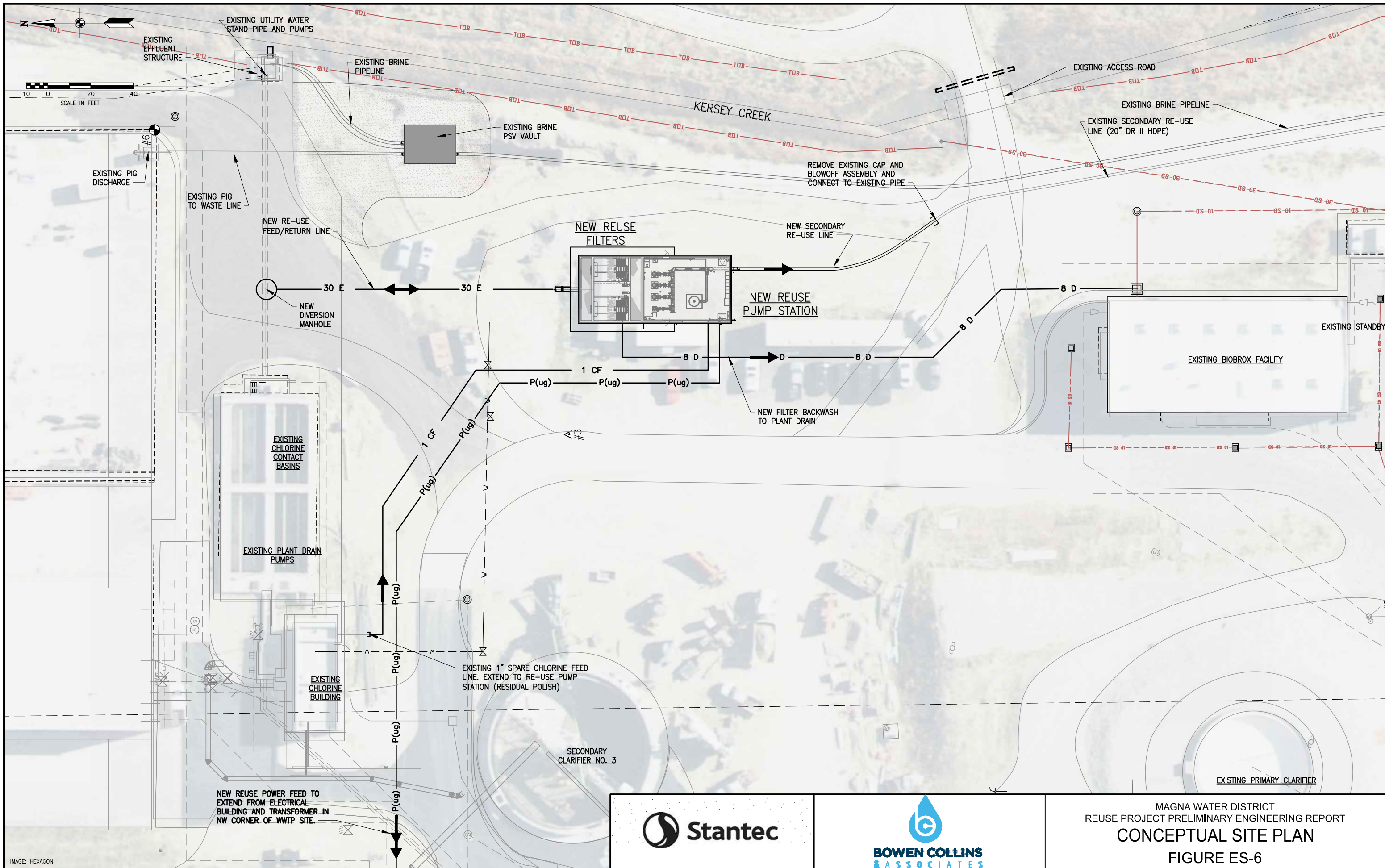

MAGNA WATER DISTRICT
 REUSE PROJECT PRELIMINARY ENGINEERING REPORT
CONCEPTUAL SITE PLAN
 FIGURE ES-6

**Figure ES-7
Effluent Land Application Limitations**

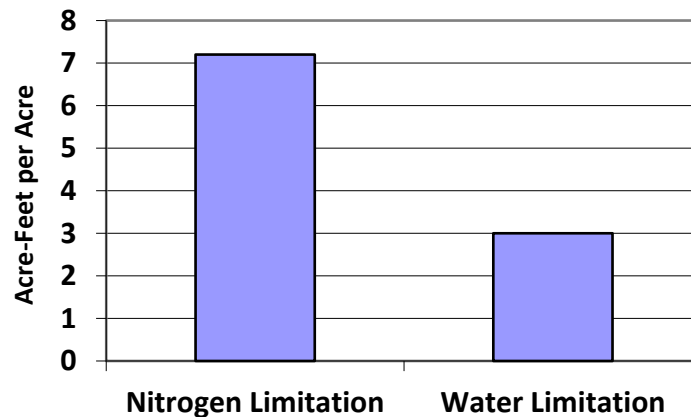

OPERATION AND MANAGEMENT PLAN

Type I Reuse water will be one of several sources that can be used within the District's secondary irrigation system. The District's secondary irrigation sources include shallow groundwater wells, Utah and Salt Lake Canal water, and the proposed Type I reuse from the Magna WWTP. All three sources are needed to meet the District's future water demands. The District will manage use of each source to maximize the beneficial use of each. It is estimated that Type I reuse will be the primary source for the secondary irrigation system.

The existing secondary irrigation system is physically disconnected from the potable water system and complies with the State of Utah cross connection rules. The District's construction standards require all new secondary irrigation piping to be clearly marked as designated for secondary use. Pipes can be marked using purple pipe, purple warning tape, and/or purple pipe wrap. Any new construction of secondary irrigation distribution system pipeline will be constructed in accordance with R317-3-11.8 including separation, identification, and other requirements.

Regular maintenance will be completed as necessary and per the manufacturer recommendations. The design of the reuse facility will allow for a unit to be taken off-line for routine maintenance while continuing to treat flows. Operation and maintenance will be completed by existing Magna WWTP staff. It is estimated that the Reuse Facility at start up flows will require an equivalent of 0.25 full time employee to operate and maintain during the summer months.

CONTINGENCY PLAN

Discharge to the C-7 Citch will serve as the contingency plan if there were to be a significant upset or failure in the reuse facility. The design of the filtration system and pump station will include redundant equipment with isolation measures to minimize the potential of operational disruptions. It is also noted that the Reuse Facility will have continuous on-line monitoring to confirm that the treated effluent meets Type I reuse requirements prior to entering the distribution system. The Reuse System will shut down if the reuse water does not meet the requirements of Type I reuse. Upon shut down the secondary treated effluent will discharge to the C-7 Ditch with passive flow diversions.

PUBLIC NOTIFICATION

Upon UDWQ approval of this Reuse Plan and prior to implementation, the District will notify all secondary irrigation users that Type I reuse water will be the preferred water source for the District's secondary irrigation system. Notice will be provided via an informational flyer to be included with the monthly bill that is sent to all District costumers as well as an electronic notification for those that receive electronic invoices. Notices be provided for two consecutive months and will be delivered at least three months prior to implementation. The notice will also be publicly posted on the District's website. The notices will provide a short summary of the need for the project, summarize water quality of reuse water, remind users that secondary water is not to be consumed, identify approved uses of secondary water, and identify a date and location for public hearing for residents to express concerns.

CONSTRUCTABILITY REVIEW

It is proposed that the Reuse Facility will be constructed on the eastern portion of the Magna WWTP property, just north of the existing BIOBROx Facility. See Figure ES-6 for the proposed location. It is estimated that the facility will be approximately 71 ft long by 31 feet wide with an estimated construction depth of 20 ft below existing grade. It is expected that ground water will be encountered during construction. Similar construction activities on the WWTP site have proven that ground water can be mitigated and controlled with proper construction dewatering activities. It is recommended that a geotechnical boring and evaluation be completed for the proposed location. Based upon review of available drawings and site investigation, there are no known utilities within the proposed location that would prevent construction.

The new facility will require significant improvements to the plant's power system. The existing back up generation system does not have capacity for the additional load from the reuse pump station.

OPINION OF PROBABLE COSTS

The following Class 3 probable project cost estimate was prepared based on information available at the time of this report and our team's experience, qualifications, and judgment as experienced and qualified professional engineers. However, since we have no control over the cost of labor, materials, equipment or services furnished by others, or over the contractor(s') methods of determining prices, or over competitive bidding or market conditions, we cannot guarantee that proposals, bids or actual project or construction cost will not vary from this opinion of probable cost. There have been significant increases in construction costs within Utah. The cost estimate below includes a 20% increase based upon current market conditions.

**Table ES-3
Reuse Facility Opinion of Probable Cost**

Item	Description	Cost
1	General Conditions	\$ 400,000
2	Site Work (Excavation, Backfill, Grading, Paving)	\$ 250,000
3	Yard Piping	\$ 400,000
4	Structural (filter bay, wet well, building)	\$ 1,900,000
5	Filter Equipment Installed	\$ 900,000
6	Vertical Turbine Pumps and Piping Installed	\$ 500,000
7	Disinfection Improvements	\$ 100,000
8	HVAC	\$ 150,000
9	Building Electrical and I&C	\$ 700,000
10	Power Supply and Back Up Generation	\$ 800,000
11	Contingency (20%)	\$ 1,160,000
12	Subtotal	\$ 7,320,000
13	Contractor Overhead and Profit (18%)	\$ 1,317,000
14	Current Bidding Market (20%)	\$ 1,464,000
15	Total Construction Costs	\$ 10,102,000
16	Administration and Engineering (18%)	\$ 1,818,000
17	Project Total	\$ 11,920,000

FUNDING ALTERNATIVES

The District has been awarded a \$4,925,000 grant as part of the WaterSMART Program. This funding is part of the United States Bureau of Reclamation (USBR) Title XVI Water Reclamation and Reuse Program. A small portion of the grant money will be set aside for USBR to ensure the project's Federal and statutory compliance, and to otherwise oversee the implementation of the project. This allocation is estimated at \$200,000. It is estimated that approximately \$4.7 million will be available to be used to pay for planning, administration, engineering or construction of the approved reuse project.

It is recommended that MWD investigate obtaining additional funding through the American Rescue Plan Act (ARPA). The ARPA is a \$1.9 trillion coronavirus rescue package designed to facilitate United States recovery from economic and health effects of the COVID 19 pandemic. As part of the overall package, \$365 billion has been earmarked for direct funding to state and local government for infrastructure projects improving transportation, water, sewer and broadband networks. These funds will remain available until 2024 or until fully utilized.

IMPLEMENTATION SCHEDULE

In 2019 the District applied for and was granted a variance to the recently implemented Technology Based Phosphorus Effluent Limit (TBPEL). This variance granted the District an interim effluent total phosphorus limit of 1.8 mg/L until January 1, 2025. After January 1, 2025, the phosphorus limit will drop to 1.0 mg/L. As part of the variance, MWD agreed to add chemical treatment for phosphorus removal, which has been completed. The District also agreed to move forward with the Reuse Project,

submitting construction plans to UDWQ by July 1, 2022 with the facility to be in operation no later than January 1, 2025.

The schedule below identifies project milestones to meet requirements of the UDWQ variance. Adherence to the schedule meets the UDWQ requirements and also allows the reuse facility to be operational prior to the 2024 irrigation season. Operating the reuse facility during the 2024 irrigation season will allow MWD to optimize the facility and provide valuable information to assist in navigating the 2025 phosphorus permit requirements.

**Table ES-4
MWD Reuse Facility Implementation Schedule**

Task	Length	2021				2022				2023				2024				2025	
		Q1	Q2	Q3	Q4	Q1	Q2	Q3	Q4	Q1	Q2	Q3	Q4	Q1	Q2	Q3	Q4	Q1	
Reuse Plan Development	6-months	█	█	█															
Reuse Plan Submitted to DWQ				◆															
Final Design	9-Months			█	█	█	█	█											
Design Submitted to DWQ	July 1, 2022							◆											
Bid Period and Award	3-months							█	█										
Construction	18-Months							█	█	█	█	█	█	█	█	█	█	█	█
Start Up and Testing	1.5 Months																		█
Optimization	3-Months																		█
Operational DWQ Requirement	January 1, 2025																		◆

2024 IRRIGATION SEASON

SECTION 1 - INTRODUCTION

1.1 INTRODUCTION

The Magna Water District (MWD or District) provides water and sewer services to the Township of Magna, Utah as well as small portions of West Valley City, Utah and Salt Lake City, Utah. Figure 1-1 identifies the District service area. MWD is committed to serving the current and future water needs within their service area. To that end, MWD recently completed the 2020 Water and Sewer Master Plans. Both of these reports identify Secondary Reuse as a priority for the District. The Water Master Plan identified reuse as a critical component in meeting future water supply needs. In the case of the Sewer Master Plan, reuse is an important element of District goals to meet treated effluent nutrient removal requirements.

The District contracted with Bowen Collins & Associates (BC&A) to provide engineering services for preliminary evaluation and final design of the 2021 Secondary Reuse Project to meet the objectives identified in the master plans. This report documents the preliminary evaluation and establishes the basis of final design for the 2021 Secondary Reuse Project and also serves as the Secondary Effluent Reuse Plan to be submitted to the Utah Division of Water Quality (UDWQ) as required by Utah Rule 317.

The plan is separated into four subsequent sections following the introduction which are based upon information and data included in a series of technical memoranda prepared for the project. The technical memoranda were presented and reviewed with District Staff in several workshops held throughout the evaluation period. The memoranda have been reformatted for each section, and conclusions and recommendations identified for the associated workshops are included. The following summarizes information included in each part.

Section 2 – Need for Secondary Water

- District Secondary Irrigation Demand – Current and Future
- Other Reuse Opportunities
- Water Quality – Type I Reuse
- Evaluation of Secondary Conveyance System

Section 3 – Reuse Facility Evaluation

- Filtration Technology Evaluation
- Disinfection Modifications
- Pump Station Evaluation
- Hydraulic Review and Conceptual Site Layout

Section 4 – Reuse Plan Supplemental Information

- Nutrient Management and Agronomic Uptake
- Operation and Management Plan
- Contingency Plan
- Public Notification

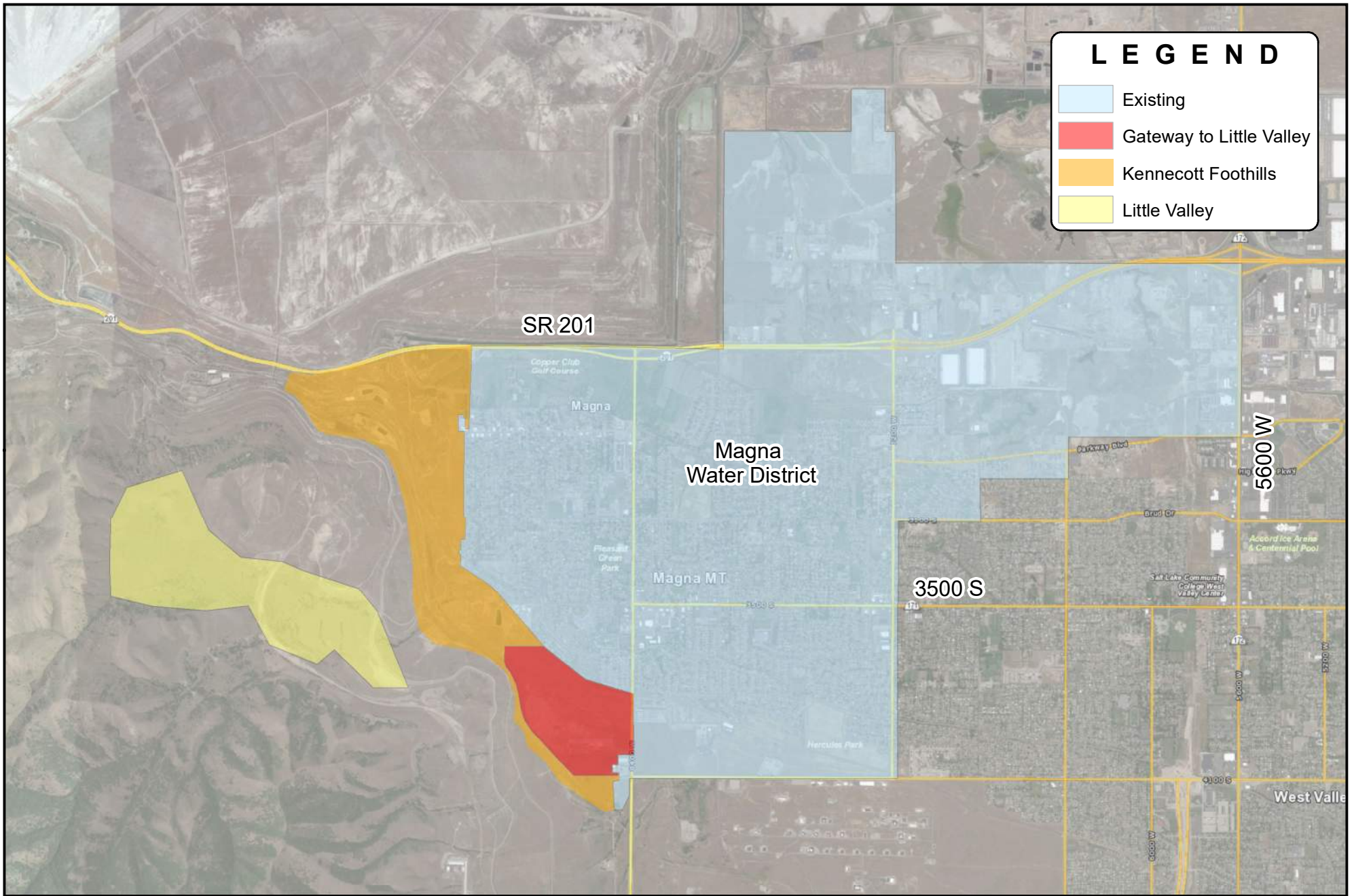

LEGEND

- Existing
- Gateway to Little Valley
- Kennecott Foothills
- Little Valley



MAGNA WATER DISTRICT
**REUSE PROJECTS
 PRELIMINARY ENGINEERING
 REPORT**

**SERVICE AREA
 WITH POTENTIAL
 ANNEXATION AREAS**

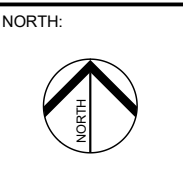

SCALE:
 0 2,000 4,000

 Feet

FIGURE NO.
1-1

Section 5 – Implementation Plan

- Constructability Review
- Electrical Capacity Evaluation
- Opinion of Probable Costs
- Funding Alternatives
- Implementation Schedule

1.2 BACKGROUND

The District is experiencing, and is expected to continue to experience, significant growth within its existing service area. Adjacent areas with planned development are also likely to annex into the District. These additional areas include the following.

- **Gateway to Little Valley** – This development sits just west of the current District service area and includes 1,290 proposed indoor equivalent residential connections to be built within the next 10 years.
- **Kennecott Foothills** – Additional area directly west of the existing District service area (beyond that identified as part of Gateway to Little Valley) is likely to develop and annex into the District. For District planning purposes, all areas directly west of the existing service area at an elevation of approximately 4,660 feet or lower are included as potential annexations. This elevation was chosen as the upper boundary of likely development as it is the current service area limitation of the District’s planned Pressure Zone 3.
- **Little Valley** – Kennecott Utah Copper has long-term plans for development in the area called “Little Valley”, which is a valley within the Oquirrh Mountains west of the District. While this area is not expected to begin development in the near future, the District intends to provide capacity, especially in its largest outfall facilities, to meet the needs of this future development.

The following master plans identify water and sewer needs for existing and future customers. Information included in these plans is the basis for population projections, future water demand projections and projected sewer flows for this report.

- Magna Sewer Master Plan, Bowen Collins & Associates, August 2020
- Magna Water Master Plan, Bowen Collins & Associates, August 2020
- Magna Conveyance and Storage Master Plan, Bowen, Collins Associates, August 2020.

1.3 ACKNOWLEDGEMENTS

The BC&A team wishes to thank the following individuals from the Magna Water District for their cooperation and assistance in working with us to prepare this report.

Clint Dilley	General Manager
Trevor Andra	District Engineer
Dallas Henline	Wastewater Operations Manager
Steve Williams	Former Wastewater Operations Manager
Raymond Mondragon	Water Operations Manager
Joel Workman	AQS Environmental

1.4 PROJECT STAFF

BC&A teamed with Stantec Consulting to complete this evaluation. The BC&A/Stanec Project team members are listed below. Questions may be addressed to Jeff Beckman, Project Manager, (801) 495-2224.

Jeff Beckman	Project Manager	BC&A
Jason Luettinger	Conveyance Facilities Lead	BC&A
Clint Rogers	Treatment Facilities Lead	Stanec
Michael Priest	Filtration Expert	Stanec
Cristina Nelson	Pump Station Lead	BC&A
Keith Larson	Planning	BC&A

SECTION 2 – NEED FOR SECONDARY WATER

2.1 INTRODUCTION

The purpose of this section is to document background information needed to establish overall design parameters for the Reuse Project. This section was previously submitted to the District as Technical Memorandum #1 and includes the following major topics. Each of these topics is discussed in the following sections.

1. **Secondary Irrigation Demand** – What demands are projected to occur within the District service area and how can reuse water be used to satisfy these demands?
2. **Other Reuse Opportunities** – What other opportunities are available to use reuse water outside of system irrigation demands?
3. **Water Quality** – What is the expected quality of water that will be generated by the reuse project, and how will this affect use of the water?
4. **Secondary Conveyance System** – How will reuse water be conveyed and used in the District secondary system?

2.2 SECONDARY IRRIGATION DEMAND

2.2.1 Need for Secondary Water

The District updated its water and sewer system master plans in 2020. Both plans identified the Secondary Reuse Project as a priority. In the case of sewer, the reuse project is an important component of District goals to meet treated effluent nutrient removal requirements. For water, the reuse project is a fundamental component of the District's future water supply.

Figures 2-1 and 2-2 from the Water Master Plan show projected annual and peak demands in the secondary system for years 2000 to 2060¹. As shown in Figure 2-1, the projected need for water on an annual basis (including a recommended buffer for supply reliability and redundancy) is expected to exceed the existing supply by 2022. The situation is more concerning for peak demands as shown in Figure 2-2. Peak secondary water demand (including the recommended reliability buffer) is already well in excess of existing supplies². Based on these demands, the Water Master Plan recommended that the District acquire additional supply as quickly as possible. Based on availability, water quality, and reliability, water reuse was identified as the top priority for secondary source expansion.

¹ Figures have been modified slightly from the master plan to reflect the increased priority of reuse water in the system and updated projections.

² This does not mean that the District is unable to meet existing demands. As long as supplies are operating without interruption, existing supplies are adequate to meet demands through approximately 2026. However, if any supply were lost or reduced as a result of drought, an algae bloom in Utah Lake, mechanical failure, etc. the District could risk having inadequate supply. Addressing this vulnerability by adding sources adequate to meet the recommended buffer is one reason for pursuing the reuse project.

**Figure 2-1
Secondary Water Production Requirements**

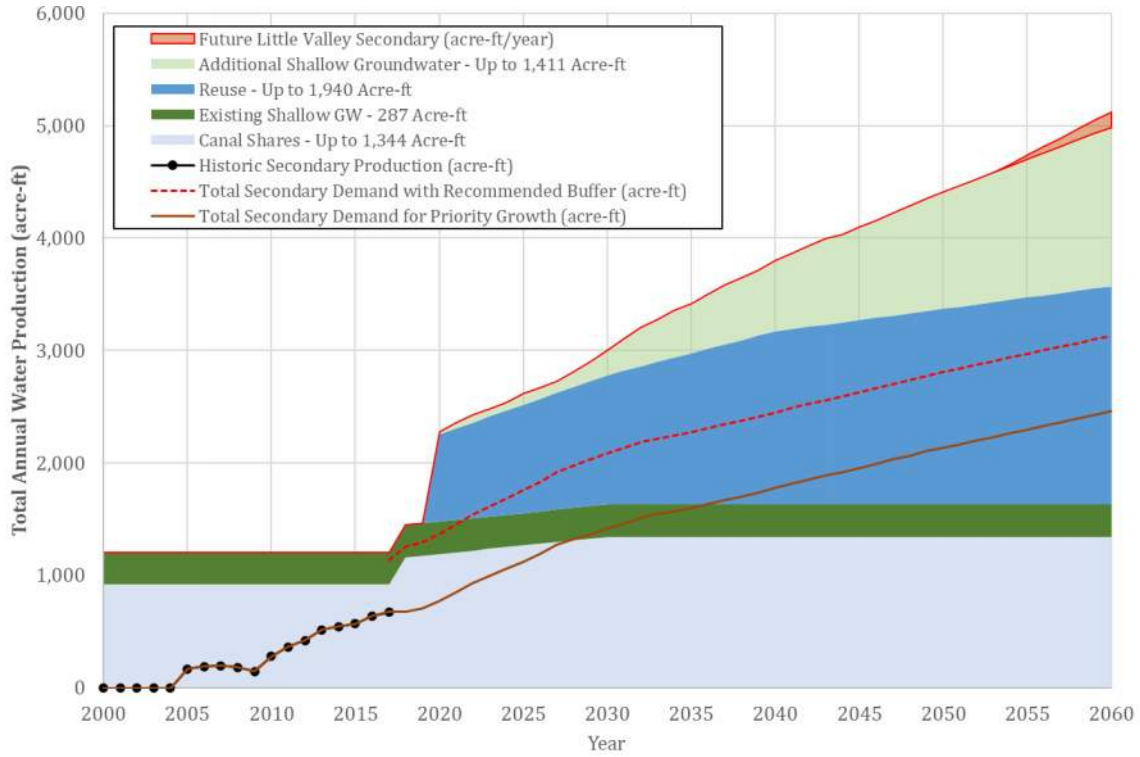

**Figure 2-2
Secondary Water Capacity Requirements**

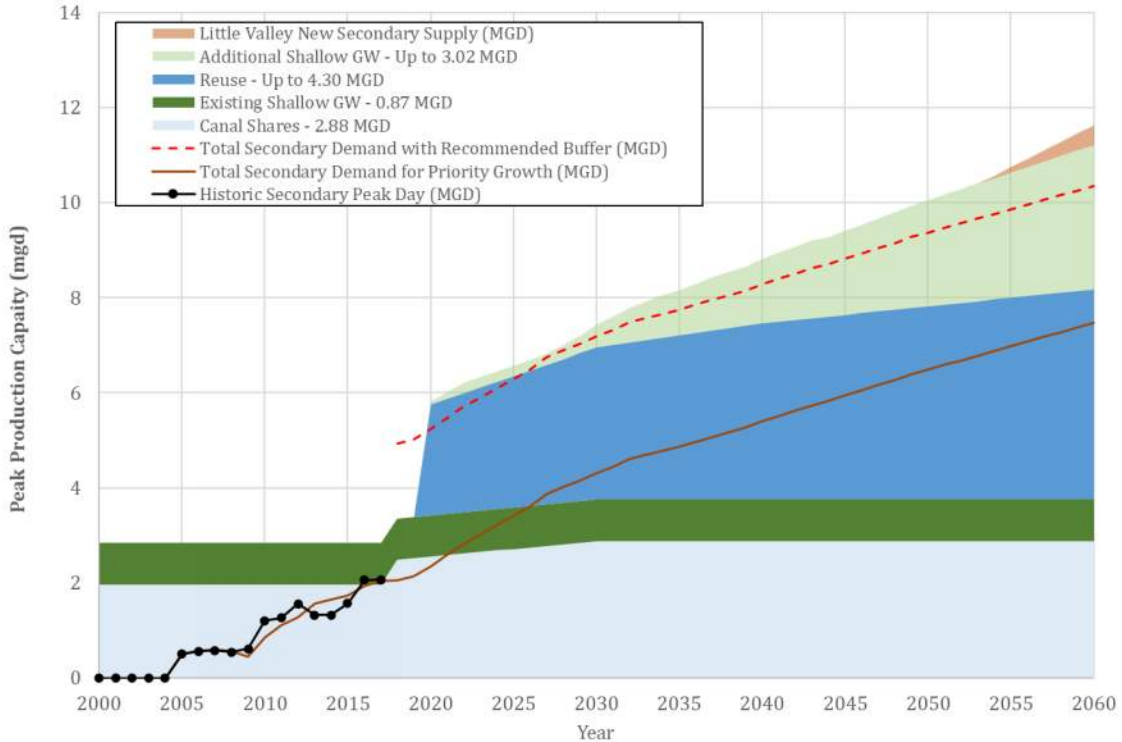

2.2.2 Peak Reuse Demand

Once reuse water is available, that supply is expected to become the preferred water source in the secondary system. This is a result of overall better water quality compared to other sources, and the benefits it provides in meeting nutrient removal requirements for treated effluent discharge to the C7 Ditch. Secondary water used for irrigation is expected to be equal to either the demand in the irrigation system or the maximum amount of wastewater available for treatment. Peak demand for reuse water (for irrigation purposes) can be projected by examining peak irrigation demand compared to available wastewater flow as shown in Figure 2-3. Peak irrigation demand is based on the projections shown in Figure 2-2. Available wastewater flow is based on projections developed in the Sewer Master Plan³. Flows are also summarized in Table 2-1.

**Table 2-1
Peak Secondary Demand vs Available Wastewater**

Year	Secondary Irrigation Demand (mgd)	Average Annual Wastewater Flow (mgd)
2020	2.35	2.61
2025	3.41	3.00
2030	4.30	3.30
2035	4.87	3.50
2040	5.40	3.71
2045	5.94	3.92
2050	6.49	4.09
2055	6.98	4.26
2060	7.47	4.43

³ Flows shown are based on average infiltration rates observed during the irrigation months and may vary from year to year depending on infiltration conditions.

Figure 2-3
Peak Secondary Demand vs. Available Wastewater

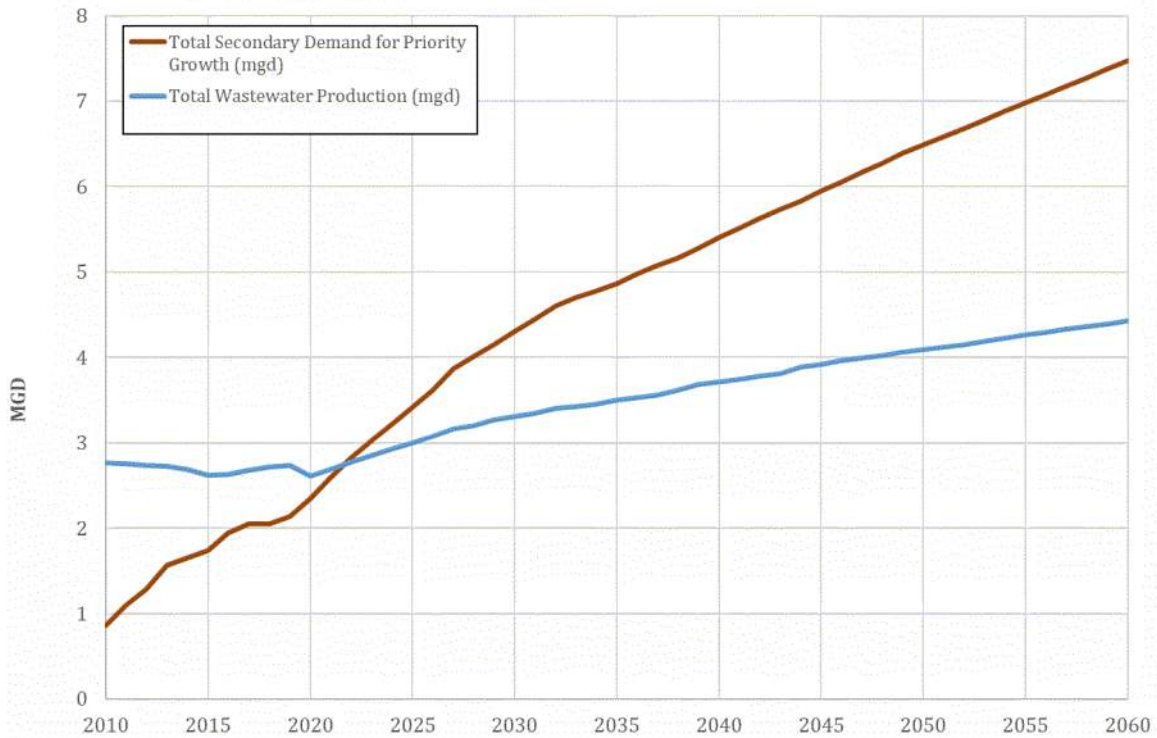

As shown in Figure 2-3, peak use of reuse water is only expected to be limited by demands for a year or two. After that time, use of reuse water during peak demands will be limited by the amount of wastewater available for treatment.

2.2.3 Seasonal Reuse Demand

Even though peak demands are expected to shortly exceed maximum available reuse, this does not mean that all the reuse water will be needed year-round. To the contrary, because of the highly variable and seasonal nature of irrigation demand, it is expected that most of the available reuse water will not be used by system irrigation demands. The District seasonal demand curve for secondary water use was compared to the available secondary reuse for the years 2020, 2040, and 2060 as shown in Figures 2-4, 2-5, and 2-6.

Figure 2-4
2020 Secondary Irrigation Demand by Month

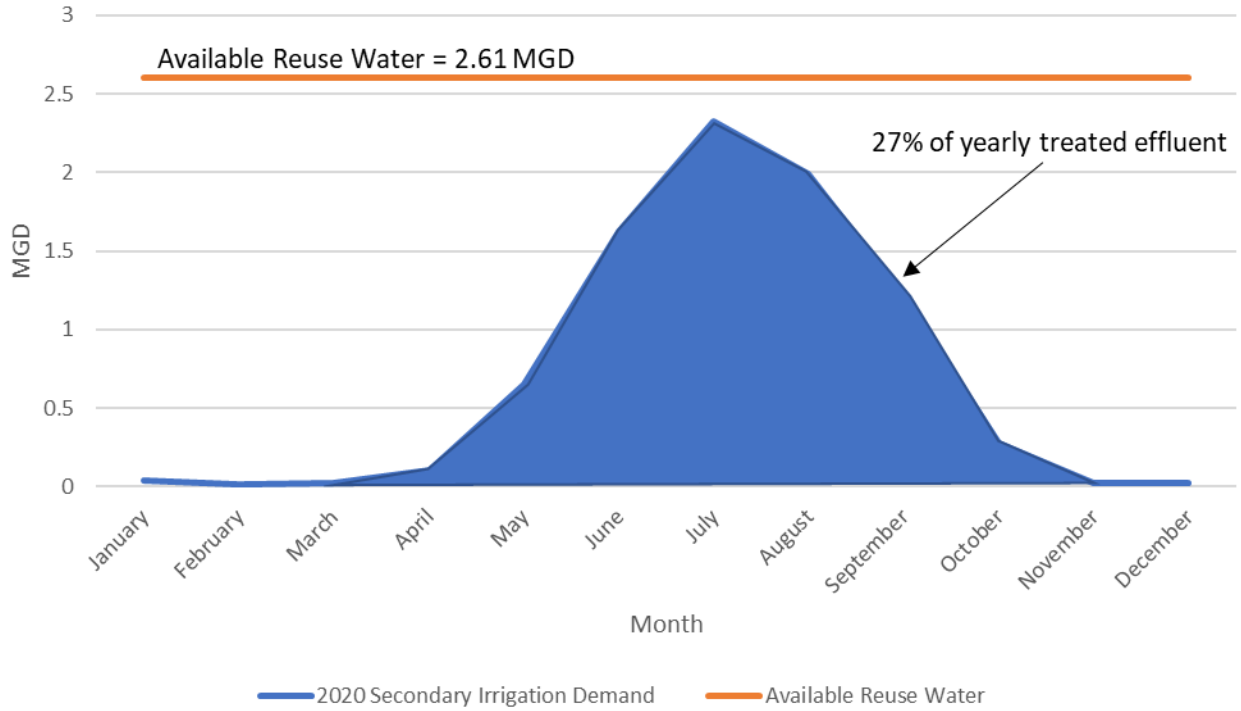
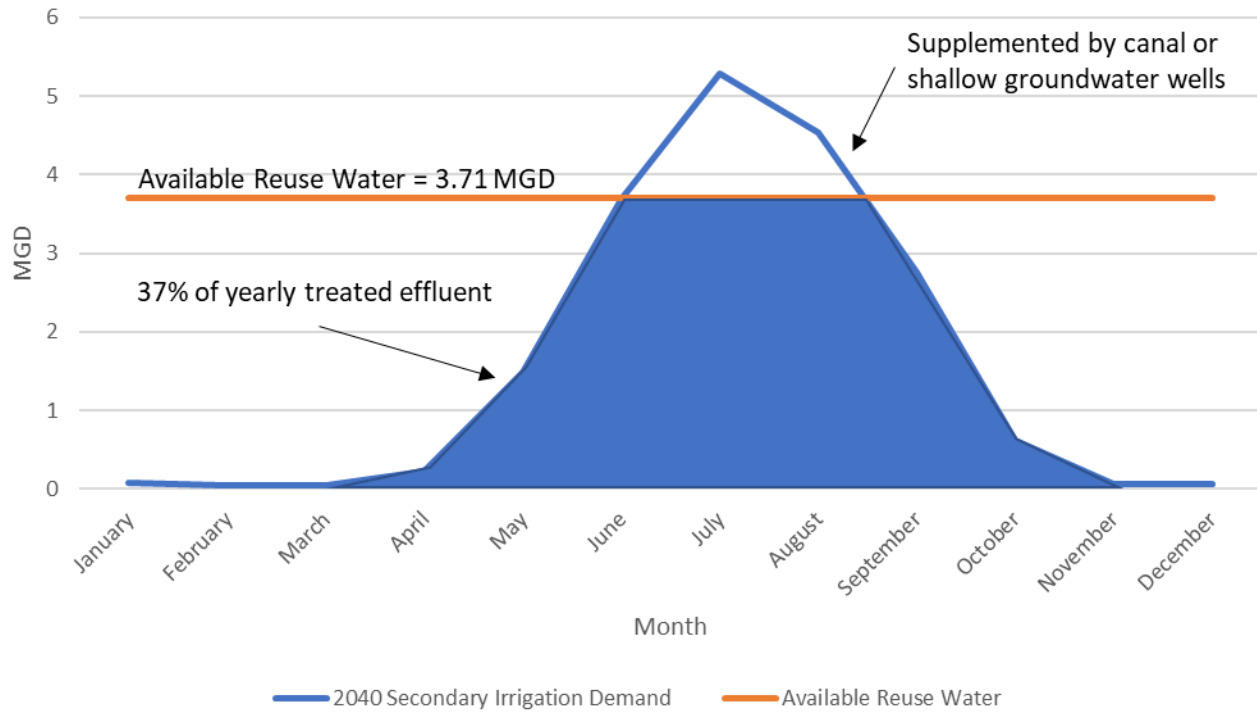
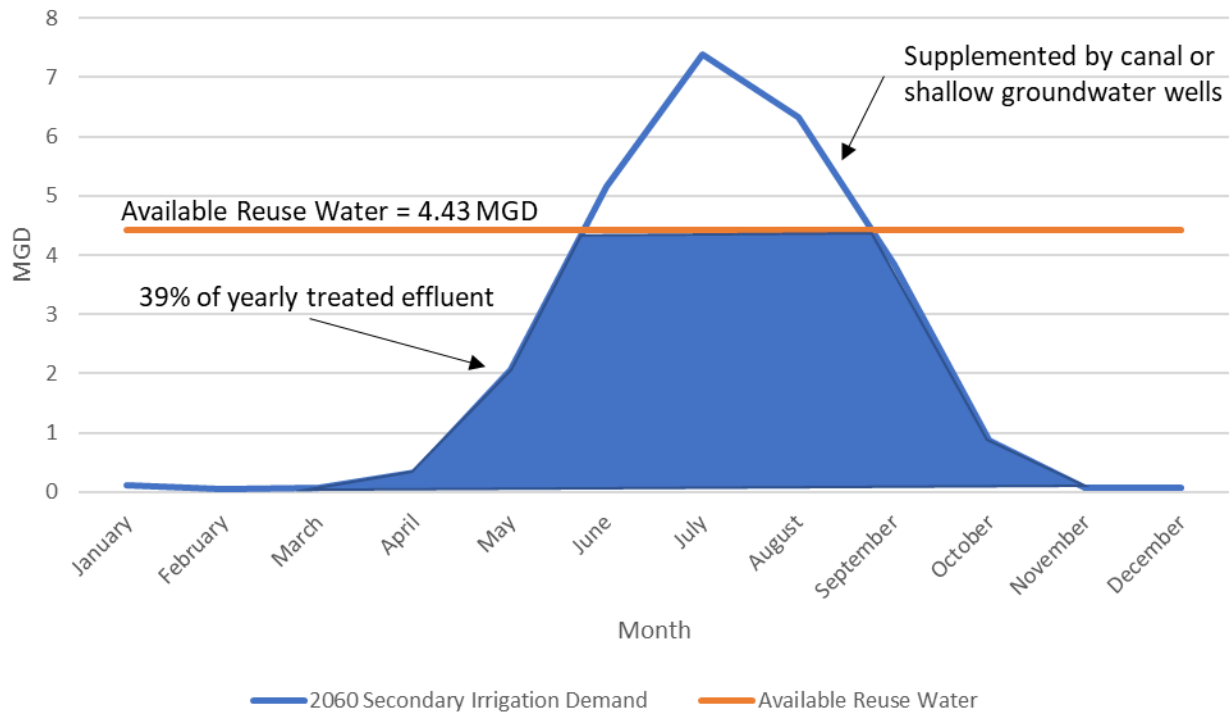

Figure 2-5
2040 Secondary Irrigation Demand by Month



**Figure 2-6
2060 Secondary Irrigation Demand by Month**



Based on projected flows shown in these figures, Table 2-2 indicates the portion of available reuse water that can be used for secondary irrigation.

**Table 2-2
Portion of Available Reuse Water Used for Secondary Irrigation**

Year	Total Available Reuse Water (acre-feet)	Portion Usable as Secondary Irrigation (acre-feet)	Percentage Usable as Secondary Irrigation
2020	2,912	775	27%
2040	4,156	1,539	37%
2060	4,962	1,940	39%

Several conclusions can be drawn from information in the above figures and table regarding the seasonal use of reuse water in the secondary irrigation system:

1. Reuse water could become the primary source of irrigation water moving forward. All of the District’s secondary water seasonal demand for 2020 can be met by available reuse water. The majority of the secondary water seasonal demand for 2040 and 2060 can be met by available reuse water. Only that portion of demand shown above the orange horizontal line in the figures in 2040 and 2060 will need to be met from other sources (canal water and/or shallow groundwater).

2. Even if use of reuse water is maximized, a majority of the available wastewater effluent still cannot be used for secondary irrigation purposes. By the year 2060, all the available reuse water can only be used for about 3 months. For the rest of the year, demands fall below available reuse flows.
3. Demand on the reuse facilities will depend on how the District uses its other secondary water sources. Except during the peak months, any water used from other sources may displace use of reuse water.

2.2.4 Other Reuse Opportunities

As shown in Figures 2-4 through 2-6, a majority of the treated effluent from the WWTP cannot be used to meet secondary irrigation demands. This is due to peak demands occurring in a limited irrigation season. The figures also indicate that the peak irrigation demands will exceed the available reuse water during the peak summer months. Additional non-summer month demands would be needed to maximize the overall annual use of treated effluent.

Several agencies in the Magna area were contacted to investigate their potential need for non-summer month water supplies. Representatives from Kennecott Utah Copper and the North Jordan Canal were contacted. Although both entities operate secondary water systems during the winter months, they indicated no need for additional supplies or sources. It is recommended that MWD continue to look for other non-summer month uses of treated reuse water.

2.3 WATER QUALITY

Previous studies and reports were collected and reviewed, and additional historical water quality information as a basis for evaluation of the existing plant effluent for suitability as Type I reuse water. This information consisted of the following:

- Wastewater Facility Plan, Final, March 2017
- Secondary Water Alternatives Report, Final, June 2020
- Sewer Master Plan, Final, August 2020
- Monthly Operating Reports, Jan. 2019 – Dec. 2020
- Monthly Operating Report Arsenic Rule Compliance – EDR, Jan. 2018 – Dec. 2020
- TDS grab samples collected between August 2017 – October 2020

The primary focus of this evaluation is to quantify and assess effluent flow and quality data for two complete years (2019-2020), with reference to historical reports as needed. Within this two-year time frame the District changed plant operations in June 2020 to segregate discharged brine from an electro dialysis reversal (EDR) process so that it is no longer blended with WWTP influent. Accordingly, the impact of removing that flow was assessed for both historical plant flow and effluent water quality.

2.3.1 Historical Flow

Historical effluent flow data for 2019-2020 was compiled for both total plant operation and EDR brine generation. From observation of the data sets, total brine flow was a significant fraction of total plant inflows until June 3, 2020 when it is estimated that all brine flows were diverted from plant influent.

During this time frame, daily brine flow was reported to vary from zero to 2.3 mgd, with an average daily flow of 0.5 mgd. This daily brine flow was subtracted from daily effluent flow to reflect an adjusted total effluent flow value. Figure 2-7 presents daily total effluent, brine, and adjusted effluent flows over this timeframe.

**Figure 2-7
2019-2020 Average Daily Effluent Flow**

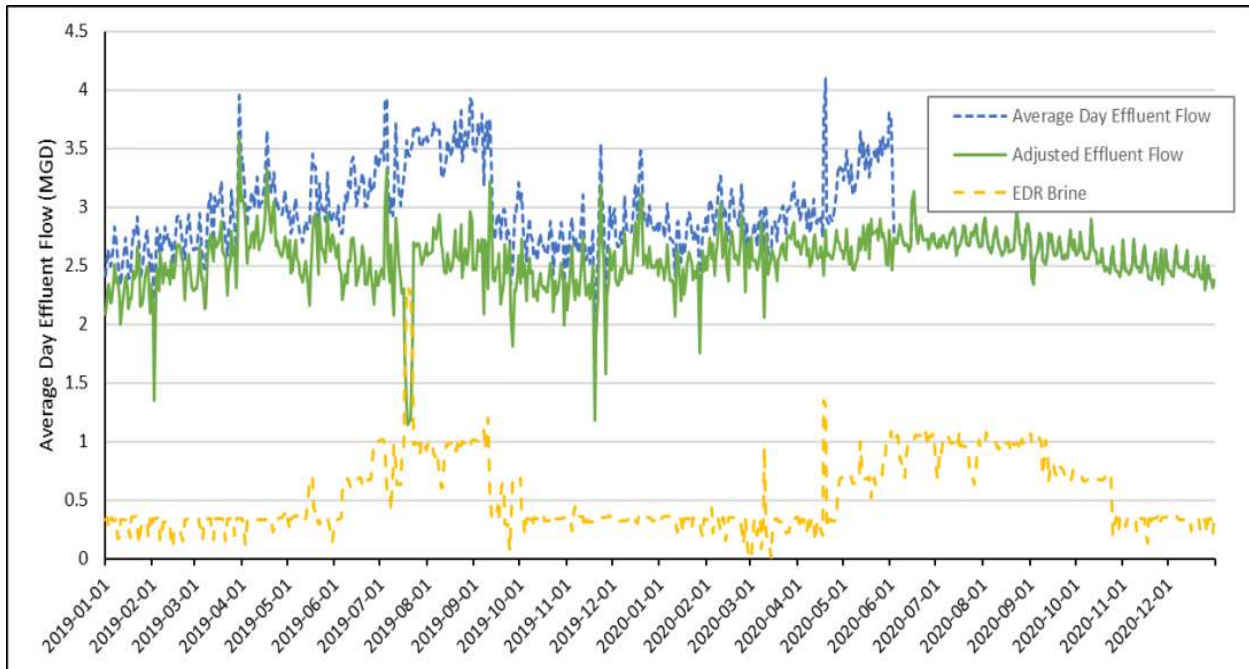

Total adjusted effluent flow varies from 2.3 to 3.1 mgd, with an average of 2.6 mgd for the two years evaluated. Table 2-3 summarizes adjusted average annual and maximum month effluent flow without EDR brine for each year. These values have been reviewed and reconciled with effluent flow projections developed under the Sewer Master Plan as reported here and in Table 2-1.

**Table 2-3
Adjusted Annual Average and Maximum Month Effluent Flow
(Brine Diverted)**

Flow	2019	2020
Annual Average, mgd	2.50	2.61
Maximum Month. mgd	2.80	2.75

2.3.2 Water Quality Requirements

Regulatory water quality criteria were summarized in the Secondary Water Alternatives Report, June 2020 which captured water quality requirements under the current Utah Administrative Code R317-3 as of January 1, 2020 and introduced additional Secondary Water System Criteria. For the purposes of this report, the Secondary Water System Criteria are not considered applicable for the design of District reuse filtration and disinfection infrastructure, although they may influence the operation of a blended water system that also utilizes other non-reuse water sources. It is recommended that these additional Water System Criteria be further evaluated during the final design process.

One aspect of the Secondary Water System Criteria that merits attention from an operations perspective is the potential for biological activity, whether bacterial or algal. Wastewater effluent that has been filtered and disinfected is not likely to directly contribute significantly to algal load and odor events in the secondary water system, but it does include sufficient nutrients to allow biological (bacterial or algal) growth in the water system. It is recommended that infrastructure tie-in points and operational management strategies be considered during preliminary design to manage this potential. This is important because as demonstrated in Figure 2-4, initial reuse flows can meet the entirety of secondary water demand but blending of the reuse water with other sources either now or in the future merits further water quality blending investigations.

The Type I reuse requirements are summarized in Table 2-4 below.

**Table 2-4
Utah Type I Requirements**

Parameter	Notes	Unit	Type I	Notes
BOD	Monthly arithmetic. mean; 24 hr. composite; n=6	mg/L	10	1
Turbidity	Daily arithmetic mean	NTU	2	2
	Maximum instantaneous	NTU	5	2
E-Coli	Weekly median	#/100 mL	ND	2
	Maximum daily grab	#/100 mL	9	
Residual Chlorine	Continuously measured	mg/L	1	3
pH	Daily grab samples or continuous monitoring	SU	6 to 9	

4. Monthly Reports provide daily grab samples. Revisit sampling methodology and frequency for reuse design basis.
5. Data not available. Revisit sampling methodology and frequency for reuse design basis, as needed.
6. Data continuously below requirement; this will be addressed under Task 3 for potential disinfection improvements and operational practices.

2.3.3 Historical Effluent Water Quality

Comprehensive water quality data for the EDR brine is not available. Accordingly, a high-level evaluation of effluent water quality following the diversion was performed, and the results were compared to water quality over the total timeframe. This method was used to assess whether historical data prior to June 3, 2020 could be used to reliably establish a design basis for reuse infrastructure, or if only data after June 2020 should be considered. Table 2-5 presents that comparison for key parameters from a regulatory and design basis for reuse infrastructure.

Table 2-5
2019-2020 Effluent Water Quality, Before and After Brine Diversion

Timeframe		1 January 2019 - 31 December 2020				3 June 2020* - 31 December 2020				Comparison		
Parameter	Unit	Minimum	Average	Maximum	No. Samples	Minimum	Average	Maximum	No. Samples	Minimum	Average	Maximum
Average Day Effluent Flow	MGD	1.5	2.9	4.1	731	2.3	2.6	3.1	212	-0.8	0.3	1.0
Adjusted Effluent Flow	MGD	1.1	2.6	3.6	731	2.3	2.6	3.1	212	-1.2	-0.1	0.5
pH	SU	7.0	7.6	8.3	731	7.0	7.4	8.3	212	0.0	0.1	0.0
BOD	mg/L	5.0	6.5	20.0	209	5.0	6.4	16.0	61	0.0	0.1	4.0
TSS	mg/L	4.0	5.2	44.0	209	4.0	5.1	10.0	61	0.0	0.1	34.0
Turbidity	NTU	TBD	TBD	TBD	TBD	TBD	TBD	TBD	TBD	TBD	TBD	TBD
Phosphorus (as P)	mg/L	1.5	2.0	2.8	24	1.5	1.9	2.3	6	0.0	0.1	0.5
Ortho-Phosphate (as P)	mg/L	1.0	1.7	2.5	24	1.0	1.5	1.9	6	0.0	0.3	0.6
E-Coli	#/100 mL	1	9	165	208	1	5	32	60	0	4	133
TDS	mg/L	1,020	1,353	1,630	9	1,020	1,115	1,290	4	0.0	238	340
Chlorine Residual	mg/L	0.4	0.7	0.8	731	0.4	0.6	0.8	212	0.0	0.1	0.0

As shown in Table 2-5, for most parameters there is consistency between the two data sets, which allows full use of the historical data to establish comprehensive and reliable criteria for the design of reuse infrastructure. Three parameters that showed the most variance were total dissolved solids (TDS), total suspended solids (TSS) and E-coli.

For TDS, the data set consists of limited sampling in March and October 2020, but suggests that following diversion of EDR brines, the effluent TDS has reduced on the order of 300-400 mg/L, with revised values in the range of 1,000-1,300 mg/L. Within that data set concurrent sampling of the Secondary Water System was performed (1,110 mg/L TDS) which suggests that reuse water can be expected to have similar TDS values as customers currently experience.

For TSS, Figure 2-8 as well as a brief statistical evaluation (9 mg/L is the 95th percentile value) indicate that extreme TSS loading values are infrequent, with most values falling within more typical concentrations that would be loaded onto tertiary cloth filters.

Figure 2-8
2019-2020 Effluent Total Suspended Solids

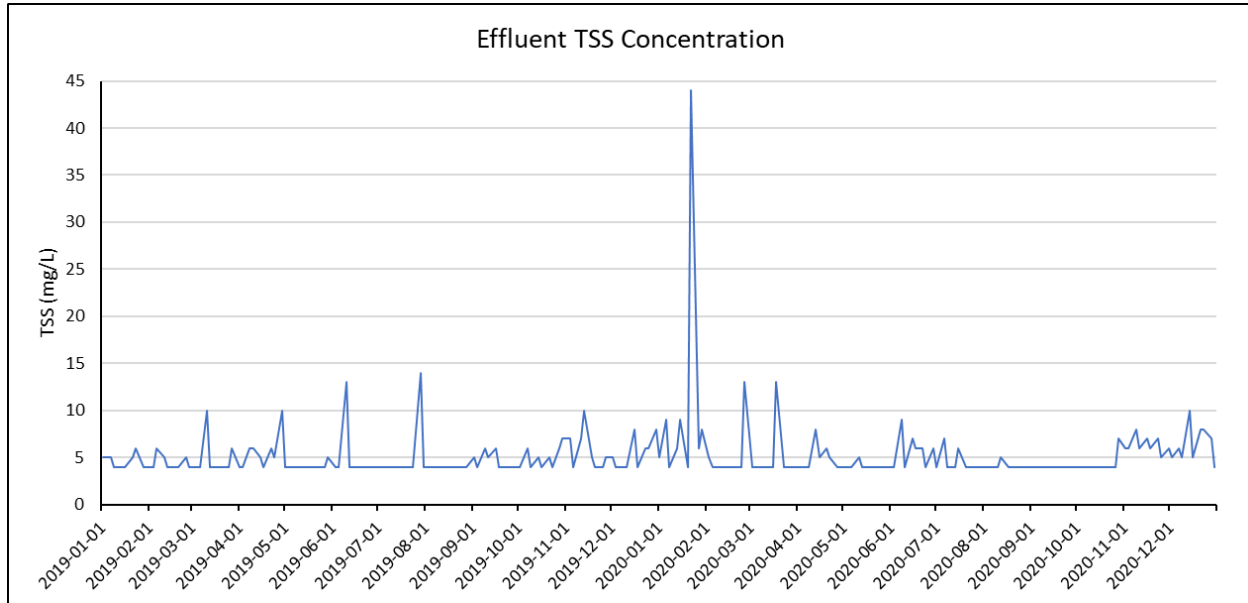

Accordingly, the maximum TSS values within both time frames are considered amenable to treatment with cloth disc filtration technologies as documented in previous studies. Solids loading criteria and the resulting recommendation for allowable hydraulic loading rates are addressed in Section 3.

For E-coli, only 73% of the data set meets the daily maximum value required for Type I reuse (9 organisms per 100 mL). Reuse Infrastructure and plant operational options to address this are evaluated in Section 3.

Figure 2-9
2019-2020 Effluent E-Coli

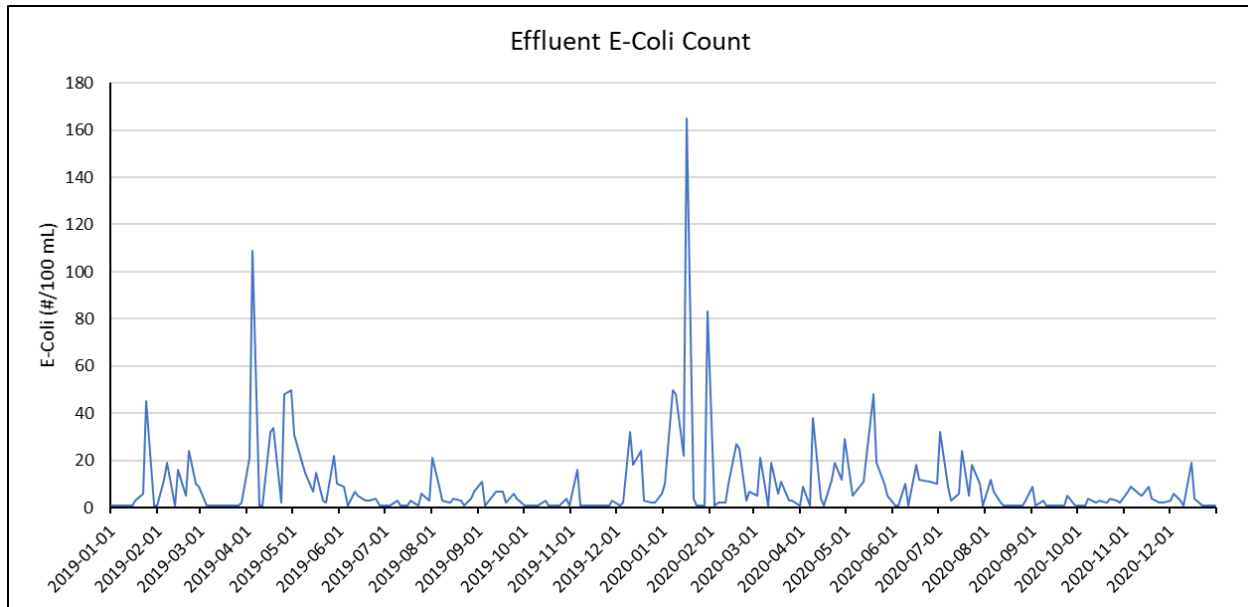

It should also be noted that both maximum TSS and E-Coli events occurred within four (4) days of each other in January 2020. It is recommended that plant operational records be evaluated for this time frame to assess whether these values represent outliers to plant operation or are valid design influent criteria. If these extreme values can be ruled out, then more economical design and operational criteria may be developed.

On a final note, Type I reuse requires a 1 mg/L chlorine residual after 30-minutes contact time. Historical values reported are consistently below this requirement. This is anticipated to be a minor issue as plant operational setpoints for the existing chlorine contact basins can be adjusted, or monitoring locations revised to better demonstrate compliance. This will be further evaluated in Section 3 in the context of potential diversion points for effluent reuse, and disinfection options.

2.4 SECONDARY CONVEYANCE SYSTEM

The final issue of consideration in this section is how reuse water will be conveyed within the secondary water transmission and distribution system. An analysis of the District's existing secondary conveyance system was performed to determine how the system would be affected by the secondary reuse project, and how proposed projects from the Water Master Plan should be implemented. The District secondary conveyance system hydraulic model was used for this analysis.

2.4.1 Planned Improvements

The Water Master Plan proposed improvements to the District's secondary water conveyance system as shown in Figure 2-10. The proposed timing for the secondary water conveyance system projects can be seen in the master plan. For the purposes of this analysis, it was deemed valuable to conduct further evaluation of timing for projects that are needed for reuse water to be implemented. Hydraulic requirements for reuse water in the secondary system will change over time as improvements are completed. This section identifies when projects are needed and how the completion of critical projects will impact operation and performance of reuse facilities.

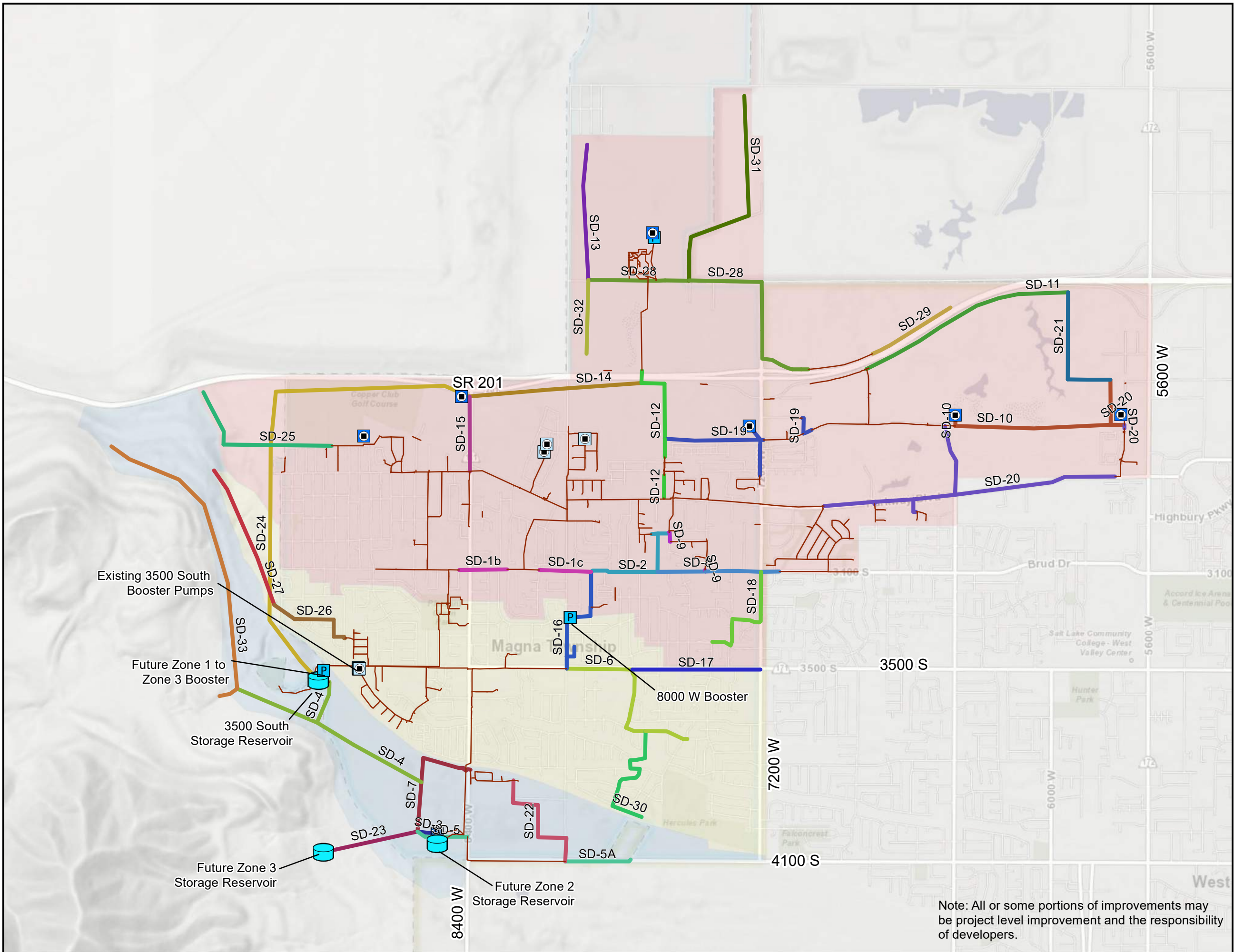

Legend

- Existing Source
- Future Source
- Booster
- Storage
- Future Pump Station
- Existing Water Lines

Pressure Zone

Pressure Zone

- 1
- 2
- 3

NORTH:

SCALE:

2060 SECONDARY PIPE IMPROVEMENT PROJECT NUMBERS

MAGNA WATER DISTRICT
 REUSE PROJECTS
 PRELIMINARY ENGINEERING REPORT

BOWEN COLLINS & ASSOCIATES

FIGURE NO. **2-10**

Note: All or some portions of improvements may be project level improvement and the responsibility of developers.

2.4.2 Modeling Approach

The existing conditions scenario (year 2020), a 20-year conditions scenario (year 2040), and a 40-year conditions scenario (year 2060, considered to be build out) were modeled. The goal of this effort was to determine the system curves needed at the reuse pump station for these three scenarios, and the timing of secondary conveyance system improvements needed for reuse water delivery.

The following assumptions were used for this modeling effort:

- The elevation of the reuse pump station was assumed to be 4,232 feet.
- Maximum and minimum pressure scenarios were calculated for the conveyance system immediately downstream of the reuse pump station. This was done to represent system curves that capture the most extreme situations that the reuse pump station could experience.
- The maximum pressure scenario at the reuse pump station was based on the following conditions:
 - Reuse supply at specified capacity
 - Shallow groundwater supplies used as needed to meet any remaining gap between reuse production and peak day demands (up to the maximum available capacity of shallow groundwater)
 - Existing Zone 1 secondary water reservoir is full
 - Zero demand (true zero demand is unlikely during periods or the year when peak day supply is needed from reuse, but demand will be minimal during off-peak hours)
- The minimum pressure scenario at the reuse pump station was based on the following conditions:
 - Reuse supply at specified capacity
 - Canal water used as needed to meet any remaining gap between reuse production and peak day demands (up to the maximum available capacity of canal water)
 - Existing Zone 1 secondary water reservoir is empty
 - Peak hour demand
- The range of flows modeled to create the system curves at the reuse pump station were determined based on the maximum potential reuse expected for each time period. Model runs were prepared for 25%, 50%, 75%, and 100% of the maximum reuse potential to show the maximum and minimum pressures downstream of the reuse pump station at each of those flow rates. It should be noted that this flow range is not intended to be a final recommendation of the operating flow range of pumps for any given scenario. Instead, it develops a robust range of system curves to be used as a guide when the design team evaluates options for pump selection.
- Friction losses in the system are based on a Hazen-Williams C-factor of 130. This approach provides a reasonably conservative representation of expected pressure losses (including minor losses) in the secondary system composed primarily of PVC and HDPE pipelines.
- The Water Master Plan defined 150 psi as the maximum pressure allowed in the secondary conveyance system. This criterion was used to determine when additional capacity is needed to convey reuse water into the system.

2.4.3 Modeling Results

Based on the modeling activities described above, results for each of the time frames are discussed in the following paragraphs.

Existing System (Year 2020). The peak demand for secondary water in 2020 is approximately 2.3 mgd (1,600 gpm). However, potentially 2.75 mgd (1,900 gpm) of flow from the treatment plant is available today (maximum month flow including infiltration). Using the hydraulic model, it was determined that only one project identified in the Water Master Plan is needed to ready the existing secondary conveyance system for flow from the reuse project at this flow rate. This is referred to as Project SD-12, and is required because there are no other existing secondary conveyance pipelines that fully connect the reuse project to the secondary water system. This project will complete that connection and allow reuse water to service the District’s existing secondary system. Other recommended secondary conveyance system projects are not yet needed because the system is capable of conveying at least 3.00 mgd (2,100 gpm) without generating pressures that exceed 150 psi.

Figure 2-11 shows the system curves produced immediately downstream of the reuse pump station in the year 2020. This includes completion of Project SD-12, but no other conveyance system improvements.

**Figure 2-11
Expected System Curve for Reuse Pump Station - 2020 Conditions**

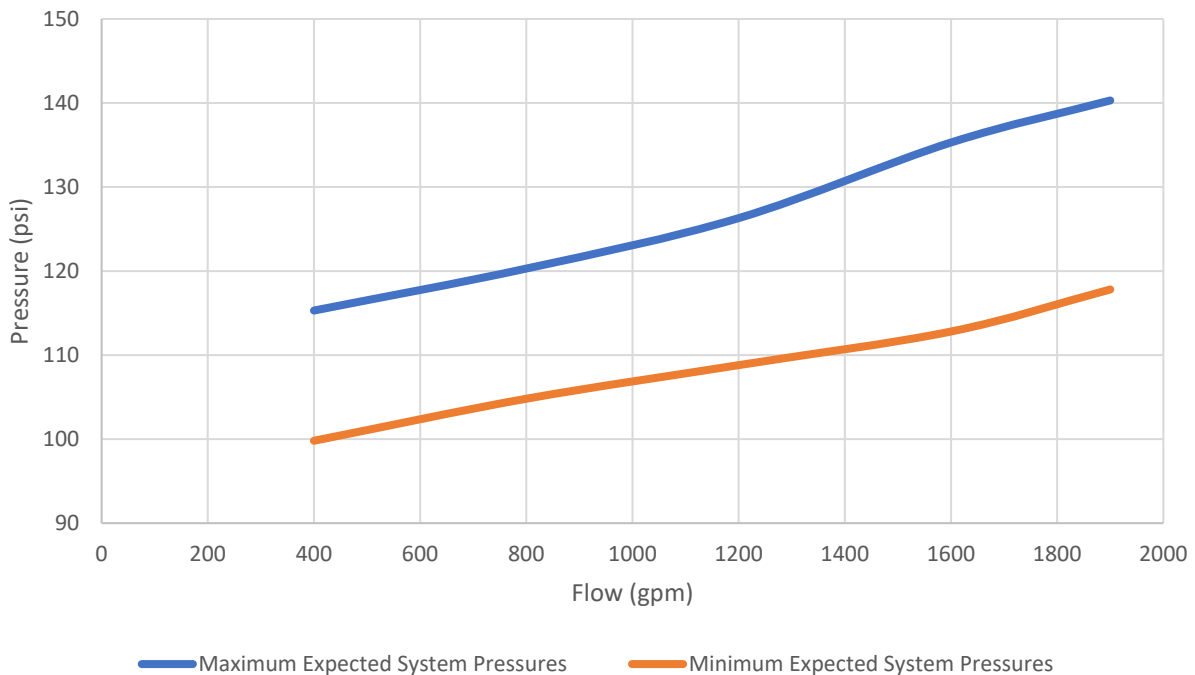

20-Year System (Year 2040). It is estimated that up to 4.0 mgd (2,800 gpm) of treated effluent will be available to meet secondary irrigation demands in 2040. Using the hydraulic model, it was determined that three projects identified in the Water Master Plan are needed to ready the existing secondary conveyance system to receive flow from the reuse project, and these are referred to as Projects SD-1, SD-2, and SD-12:

- As previously discussed, Project SD-12 is the first project needed to convey water to the rest of the secondary water system. Completion of this project will allow the District to convey up to 3.0 mgd (2,100 gpm) of reuse water into the system. Based on current growth projections, it is expected that this addition will provide capacity to convey all available reuse water through the year 2027.
- Once the reuse production exceeds 3.0 mgd (2,100 gpm), Projects SD-1 and SD-2 will be needed so that pressures within the secondary system do not exceed 150 psi. Once these two projects are completed, the system should be capable of conveying all available reuse water through at least 2040.

Figure 2-12 shows system curves produced immediately downstream of the reuse pump station in the year 2040. This includes completion of Project SD-12, SD-1, and SD-2, but no other conveyance system improvements.

Figure 2-12
Expected System Curve for Reuse Pump Station - 2040 Conditions

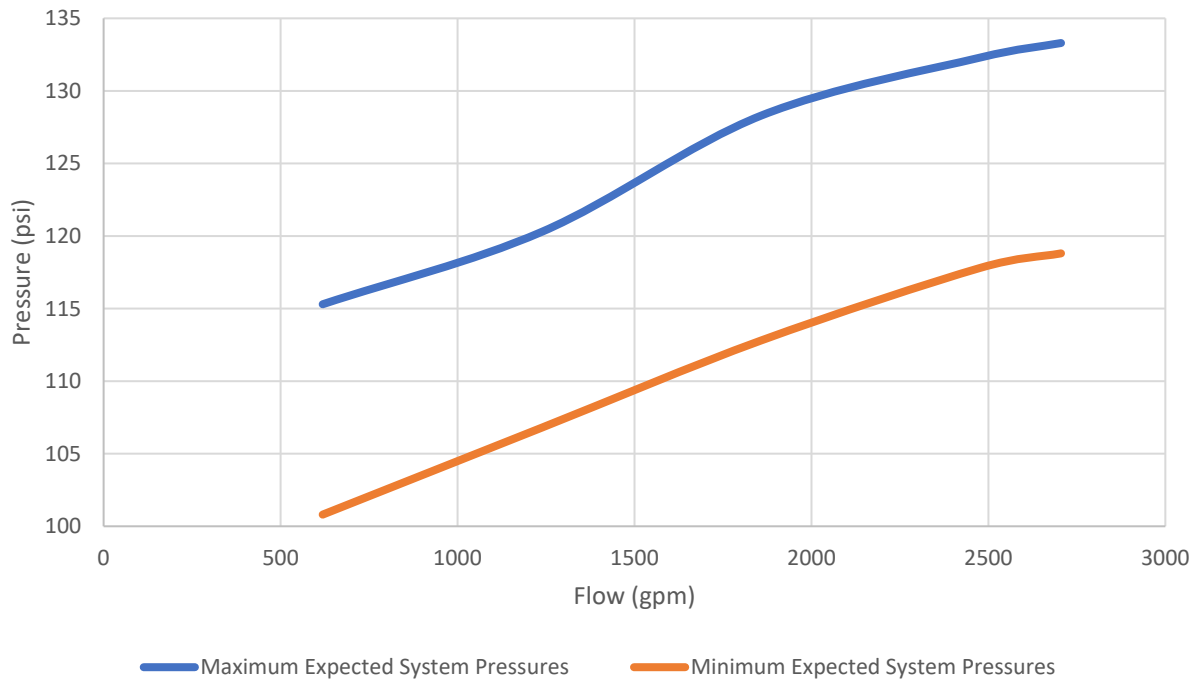

40-Year System (Year 2060). It is estimated that approximately 4.65 mgd (3,230 gpm) of treated effluent will be available to meet secondary irrigation demands in 2060. Figure 2-13 shows the system curves produced immediately downstream of the reuse pump station in the year 2060. This represents full build out conditions in the District. For these conditions, it was assumed that all projects identified in the Water Master Plan will be completed.

Figure 2-13
Expected system Curve for Reuse Pump Station - 2060 Conditions

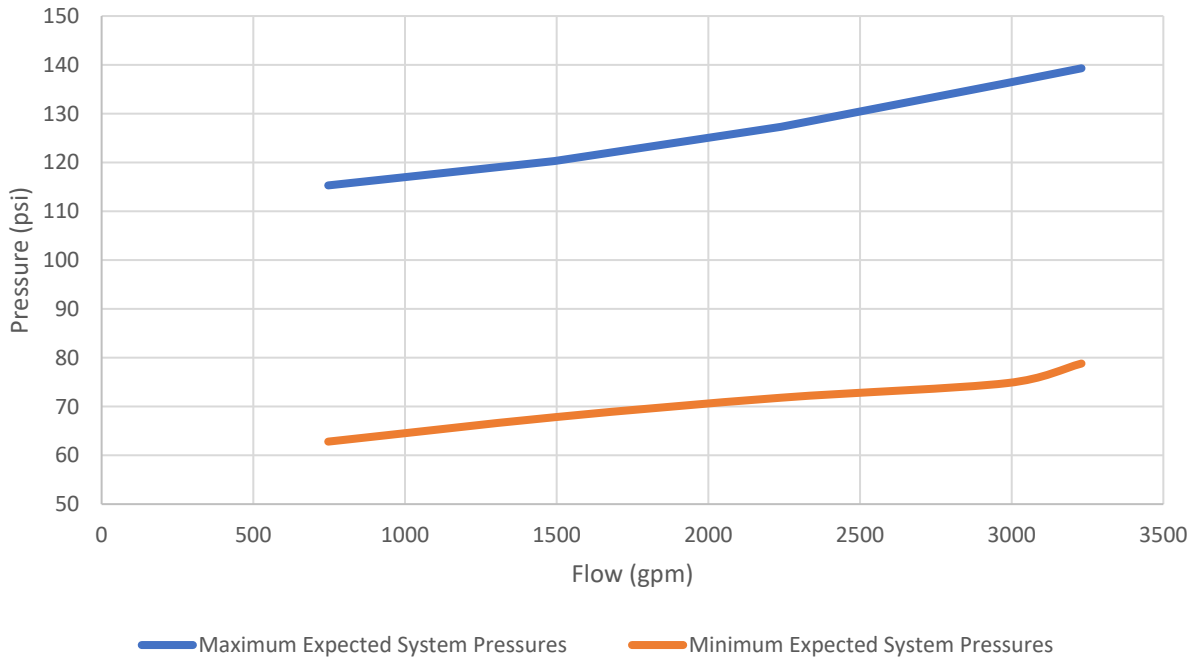

Combined System Curves (Years 2020, 2040, and 2060). Figure 2-14 shows the combined system curves for the years 2020, 2040, and 2060. This figure will assist in selecting pumps for the reuse pump station. System curves for the years 2020 and 2040 have relatively narrow pressure ranges compared to the range of pressures in 2060. This difference is primarily the result of system demands. Because the reuse pump station will be on the opposite end of the system from the Zone 1 storage reservoir, pressures at the pump station will vary more significantly between periods of peak demand and low demand as a result of pipe friction losses. In 2020 and 2040, demands are comparatively small and friction losses are lower, resulting in less pressure swing at the pump station. In 2060, demands and friction losses are much greater, even with the completion of recommended improvements.

Again, it is not intended that Figure 2-14 be interpreted as a final recommendation for the operating flow range of pumps for any given scenario. Instead, it is intended to show a full range of system curves to be used as a guide as the design team evaluates options for pump selection.

Figure 2-14
2020, 2040, 2060 System Curves

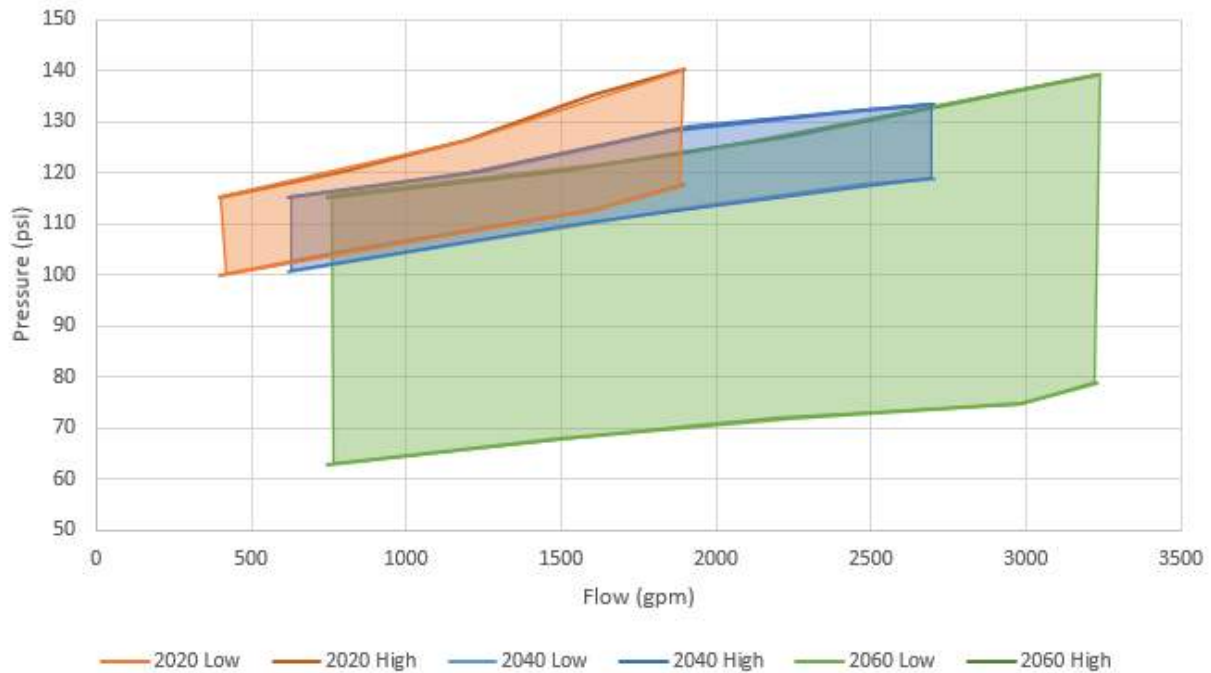

2.5 CONCLUSIONS AND RECOMMENDATIONS

Major conclusions and recommendations contained in this section are summarized as follows:

1. Reuse water will likely become the primary source of irrigation water moving forward. All the District's secondary water seasonal demand for 2020 can be met by available reuse water. A majority of the secondary water seasonal demand for 2040 and 2060 can be met by available reuse water. A comparatively small portion of demand in 2040 and 2060 will need to be met from other sources (canal water and/or shallow groundwater).
2. Even when use of reuse water is maximized, a majority of the available wastewater effluent cannot be used for secondary irrigation purposes. By the year 2060, all the available reuse water can be used for about 3 months during irrigation. For the rest of the year, demands fall below available reuse flows.
3. Demand on the reuse facilities will depend on how the District uses its other secondary water sources. Except during peak months, any water used from other sources may displace use of reuse water.
4. The current historical data set is sufficient for establishing design criteria for reuse infrastructure. It addresses most regulated Type I requirements and some Secondary Water System Criteria.
5. It is recommended that the District initiate capturing data relevant to Type I requirements that are not currently reported (e.g., weekly median E-Coli and turbidity). It is also recommended that additional data listed under the Secondary Water System Criteria (e.g., chlorides, sulfates) be collected as it may be relevant to operating a combined water system

in the future that blends both water sources, even though it may not be required to establish a design basis for the planned reuse infrastructure.

6. While wastewater effluent that has been filtered and disinfected is not likely to contribute to algal load and odor events in the secondary water system, it does include nutrients that could require operational strategies to manage the potential for biological growth which could increase bacterial or algal loads in the water system. It is recommended that infrastructure tie-in points and blending strategies be considered under preliminary design to manage this potential.
7. It is recommended that plant operational records be evaluated for January 2020 to assess whether maximum TSS and E-Coli events values represent outliers to plant operation or are valid design influent criteria. If these extreme values can be disregarded, it may allow for a less conservative design and operational criteria to be developed.
8. The District will need to construct Project SD-12 to initially connect the reuse project with the rest of the existing secondary water conveyance system. Once the reuse production grows to 3.0 mgd (projected to be around 2027), Projects SD-1 and SD-2 are needed.
9. Estimated operating ranges for the reuse pump station will evolve over time as the reuse production grows from years 2020 to 2060 and as the recommended secondary water conveyance system projects have been constructed.

SECTION 3 – REUSE FACILITY EVALUATION

3.1 INTRODUCTION

The purpose of this section is to document conceptual design development for the proposed reuse facilities. This section was previously submitted to the District as Technical Memorandum #2, and includes additional information for following major topics:

1. **Reuse Facilities Overview** – An overview of the anticipated reuse facilities is presented.
2. **Filtration Technology Evaluation** – Cloth media filtration recommendations presented in the *2020 Secondary Water Evaluation Report* are reviewed, updated and further developed.
3. **Disinfection Modifications** – The existing chlorine disinfection system is assessed and recommendations to modify the system for compliance with reuse requirements are presented.
4. **Pump Station Evaluation** – Alternatives for pumping treated water to the secondary water system are evaluated and recommendations are presented.
5. **Hydraulic Review and Conceptual Site Layout** – A conceptual site plan and an evaluation of system hydraulics are presented.

Each of these topics is discussed in the following sections.

3.2 REUSE FACILITIES OVERVIEW

As previously addressed in Section 2, Utah Division of Water Quality (UDWQ) regulations for reuse stipulate requirements relevant to both filtration and disinfection processes. It is anticipated that these reuse requirements will be met by a combination of the District's existing chlorine disinfection processes and a new cloth media filtration facility.

Under the proposed treatment scheme, effluent from the existing secondary clarifiers will continue to be injected with chlorine from a chlorine gas/solution eductor system and disinfected in the chlorine contact basins (CCBs). Depending on secondary water demand, all or a portion of the CCB effluent will be diverted to a new tertiary cloth disc media filtration facility. Influent flow rates that exceed the secondary water demand will continue to be discharged in compliance with the UPDES permit via the existing effluent structure. Water entering the tertiary facilities will first pass through an influent channel and weir prior to passing through the filter cells. A forebay collects the filtered water, which is then delivered to the secondary water distribution system by a new reuse pumping station. Figure 3-1 shows the process flow diagram for the reuse portion of the treatment plant. This configuration and sequence of processes satisfies several requirements and constraints as follows:

- It allows the existing plant to be operated per current practice to meet UPDES requirements through the existing outfall,
- It allows efficient treatment and cost management in that only the water being reused is treated to reuse standards,
- It allows cost-effective use of the existing disinfection facilities rather than construction of replacement infrastructure.

3.3 FILTRATION TECHNOLOGY EVALUATION

Based on previous reports and evaluations completed for the District (refer to the *Secondary Water Alternatives Report* dated June 2020 in the appendices), tertiary cloth media disc filtration was

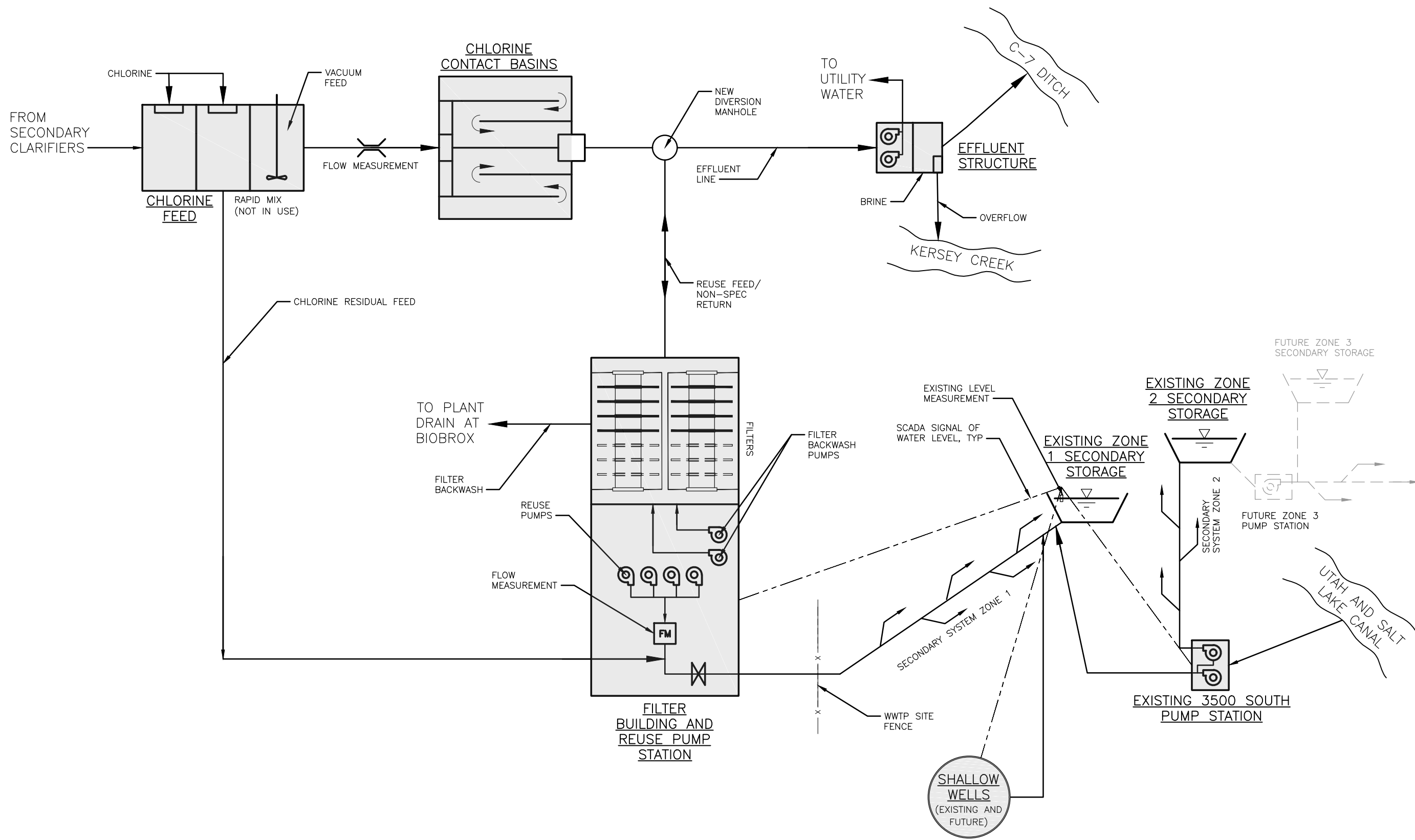

MAGNA WATER DISTRICT
 REUSE PROJECT PRELIMINARY ENGINEERING REPORT
REUSE PROCESS SCHEMATIC
 FIGURE 3-1

selected as the best option to treat secondary effluent for irrigation and agricultural reuse purposes. The State of Utah allows alternate filtration technologies under the Administration Code (R317-1-11, paragraphs 11.3 and 11.4.B.1.b).

Cloth media filtration is a proven filtration technology with numerous operating facilities within the United States and worldwide. (The South Valley Water Reclamation Facility in West Jordan, Utah has operated a cloth media disc filter by *Aqua-Aerobic* for treated secondary effluent polishing for on-site use for more than 10 years.) For example, and comparison, the western state with criteria that most closely matches Utah's Type 1 requirements is California under their Title 22 Water Recycling Criteria. Per California's latest published *Alternative Treatment Technology Report for Recycled Water* (September 2014), there are eight (8) manufacturers of thirteen (13) cloth media configurations that meet Title 22 performance criteria for recycled water. A subset of these technologies was used to frame and develop the concept design approaches adopted for this project.

The table below summarizes these criteria and correlates them to Utah Type 1 requirements.

**Table 3-1
Cloth Media Filtration Performance Requirements**

Parameter	Notes	Unit	Utah Type I	California Title 22
Hydraulic Loading Rate	Maximum instantaneous	gpm/sf	5	5
Coagulation Pretreatment	Conditionally required ¹	-	n/a	Yes ¹
Turbidity	Daily arithmetic mean	NTU	2	2
	Daily maximum ²	NTU	n/a	5
	Maximum instantaneous	NTU	5	10
Total Suspended Solids	Prior to disinfection	mg/L	5	n/a

1. Not required when filter effluent turbidity does not exceed 2 NTU, the turbidity of the influent to the filters is continuously measured, the influent turbidity does not exceed 5 NTU for more than 15 minutes and never exceeds 10 NTU, and that there is the capability to automatically activate chemical addition or divert the wastewater should the filter influent turbidity exceed 5 NTU for more than 15 minutes.
2. 5 NTU more than 5 percent of time in a 24-hr period.

MWD proposes to implement cloth media filtration per Utah Type I criteria and performance requirements as described in this memorandum, and requests approval of this approach. A variety of disc filters from different manufacturers were evaluated and are presented in the following subsections.

3.3.1 Cloth Media Filtration Basics

Cloth media disc filtration is an effective filter technology, particularly for reuse applications. Water enters the filter tank by flowing over an influent weir where it partially or completely submerges the filter discs depending on manufacturer layout. Water is treated through the disc filter from either an outside-in or an inside-out flow path, again depending on the manufacturer. Solids accumulate on the cloth media and the treated water flows out of the discs to an effluent channel. Headloss across the filters increases as solids accumulate on the cloth media and is monitored by continuous measurement of the water surface elevation upstream and downstream of the disc filters. A backwash cycle initiates once the headloss reaches a programmable setpoint or user-determined time duration. During the backwash cycle, discs are stripped of accumulated solids. Backwash water is returned to the plant headworks. Heavier solids not captured by the cloth media settle on the

bottom of the tank and are periodically pumped back to the headworks or other solids collection area of the treatment plant. Figure 3-2 shows an image of a typical disc filter.

**Figure 3-2
Typical Disc Filter**



3.3.2 Candidate Technologies

Disc filtration is an established technology with hundreds of installations in the U.S. in the last decade that serves as an alternative to conventional granular media filtration. Table 3-2 provides a summary of common disc filtration technologies currently on the market.

**Table 3-2
Cloth Media Filter Technologies and Proposals Solicited**

System Supplier	Product	Filtration Mode	Disc Rotation
Aqua-Aerobic	AquaDisk	Outside-In	During backwash only
Alfa Laval	Iso-Disk	Outside-In	Always stationary
Entex Technologies	FlowTex	Outside-In	Always stationary
Evoqua (Siemens)	Forty X	Inside-Out	During filtration and backwash
Five-Star Filtration	Five-Star Disk Filter	Outside-In	Always stationary
Nexom	Infini-D	Outside-In	Always stationary
Nordic Water	Dynadisk	Inside-Out	During backwash only
Veolia (Kruger)	Hydrotech	Inside-Out	During filtration and backwash

Proposals were solicited from four of the leading disc filter manufacturers that have a history of installations and technical expertise for this application. These manufacturers were:

- Aqua-Aerobic
- Evoqua
- Five-Star Filtration
- Nexom

The selected manufacturer products have a range of demonstrated loading rates, filtration modes, operational characteristics and unique features that can provide value to the treatment process. The vendors selected have demonstrated the capability to meet UDWQ reuse requirements, with approved hydraulic loading rates of 5 gpm/sf as well as having achieved California Title 22 certification.

3.3.3 Vendor Proposal Criteria

Disc filter manufacturers were provided with a list of design criteria outlined in Table 3-3 and described herein.

**Table 3-3
Cloth Media Filter Vendor Proposal Criteria**

Parameter	Notes	Unit	Value
Design Flow	Initial / Buildout	mgd	4.0 / 4.65
Number of Trains		each	2 ¹
Filter Cell Installation / Construction Method		-	Concrete
Maximum Hydraulic Loading Rate	UDWQ	gpm/sf	5
Influent Water Quality			
Turbidity	Average	NTU	2.26 ²
TSS	Maximum	mg/L	20
Chlorine	Maximum	mg/L	1.5
Effluent Water Quality³			
TSS	Maximum	mg/L	5
Turbidity	Daily arithmetic mean	NTU	2
	Maximum instantaneous	NTU	5
E-Coli	Weekly median	#/100 mL	ND
	Maximum daily grab	#/100 mL	9
Residual Chlorine	Continuously measured	mg/L	1

¹ A discussion of redundancy and reliability is presented in following paragraphs.

² Turbidity is a new measurement with only 21 sampling events since starting in March 2021. The first two samples were high at 16.5 and 10.9 ntu, but these were collected during a known plant upset.

³Effluent water quality as required by UDWQ R317.

Initial and buildout design flows were established in Section 2 and are provided to ensure sufficient room is incorporated into the filter tank to allow for more discs to be added as influent flows increase over time. A minimum of two filter trains was specified as discussed further below (see “Reliability and Redundancy” subsection).

Disc filters are provided in a skid-mounted steel tank (provided by the manufacturer) or in a concrete tank provided by others. For this project, vendors were directed to assume that concrete basins would be used to satisfy the following project requirements and site constraints:

1. Gravity flow into the filtration system is preferred by District staff for simplicity and to save on life cycle costs associated with operating a pump station.
2. The existing chlorination facilities at the site are partially buried and the water surface is at or below grade for most flow scenarios.
3. Providing the disc filters in a steel tank would require installation in a concrete basement. Installation into a concrete filter cell results in a simpler and more compact footprint.
4. Concrete is more durable and has a longer life expectancy than steel tanks.

The maximum hydraulic loading as stipulated under UDWQ requirements was also provided to each manufacturer. Each was asked to propose a compliant design hydraulic loading rate based on operational experience with their product, and the historical water quality and treatment process performance of upstream District facilities.

As noted in Section 2, water quality data from years 2019-2020 was compiled and a statistical evaluation performed to determine the filter influent design criteria. A conservative influent concentration of 20 mg/L of total suspended solids (TSS) was used for the design basis to ensure robust tertiary treatment capability. Limited influent turbidity data has been collected since TM #1 was prepared, but was shared to allow candidate technology providers the ability to advise on whether their operating experience indicates that a coagulant or filter-aid polymer would be required to ensure compliance with regulated effluent turbidity requirements. Finally, maximum influent chlorine concentrations were also defined since the filters are anticipated to be downstream of the CCBs. This gave the manufactures an opportunity to provide feedback on filter media compatibility and design life/risk of oxidation.

Effluent water quality values were provided to manufacturers to ensure that their disc filters could meet UDWQ Type I reuse requirements.

3.3.4 Generalized Filter Layout

Each disc filter manufacturer has a unique filter cell configuration. Figures 3-3 to 3-6 present representative isometric models and plan view drawings from each disc filter manufacturer.

**Figure 3-3
Aqua-Aerobic: Representative Filter Configuration**

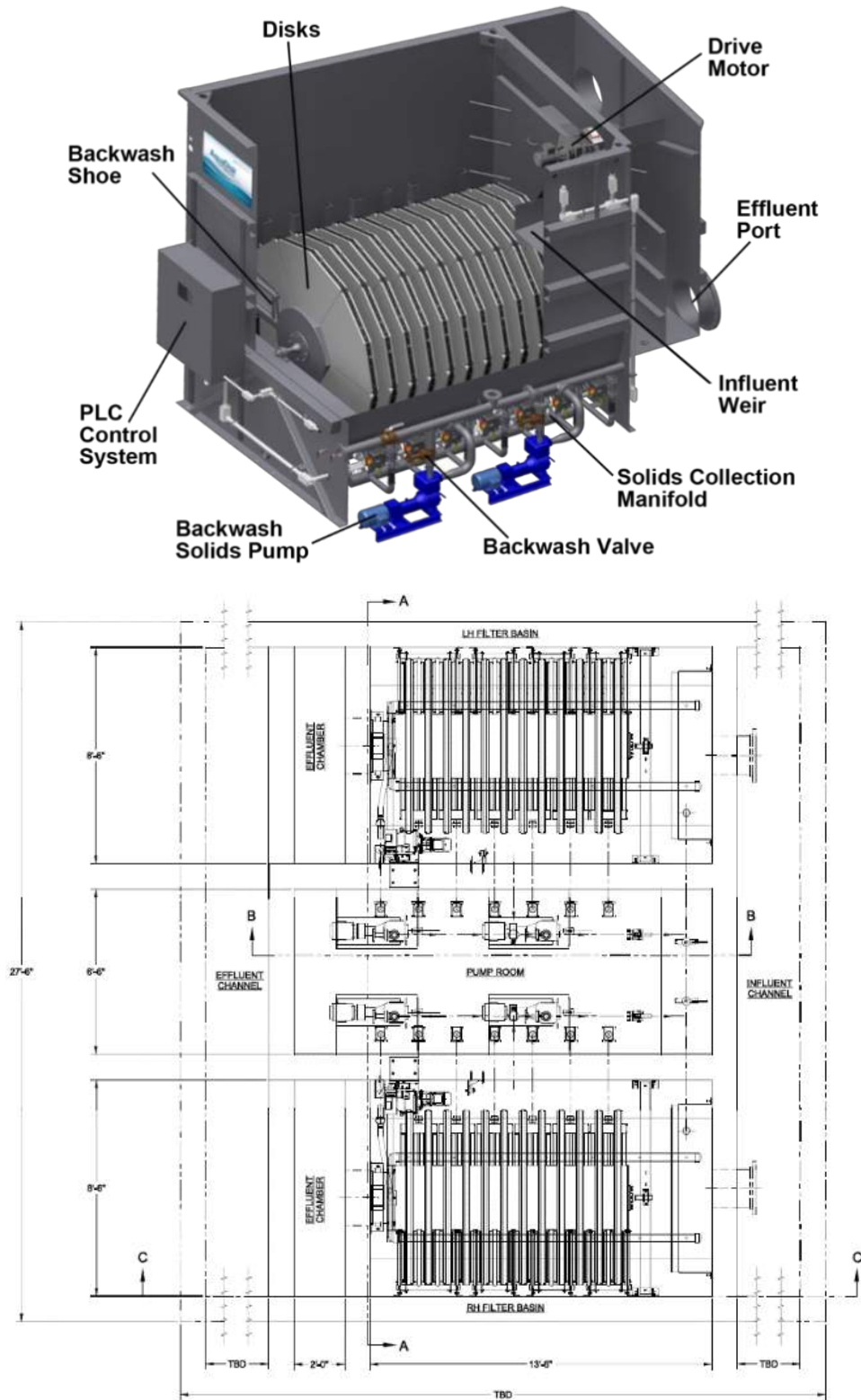

Figure 3-4
Evoqua: Representative Filter Configuration

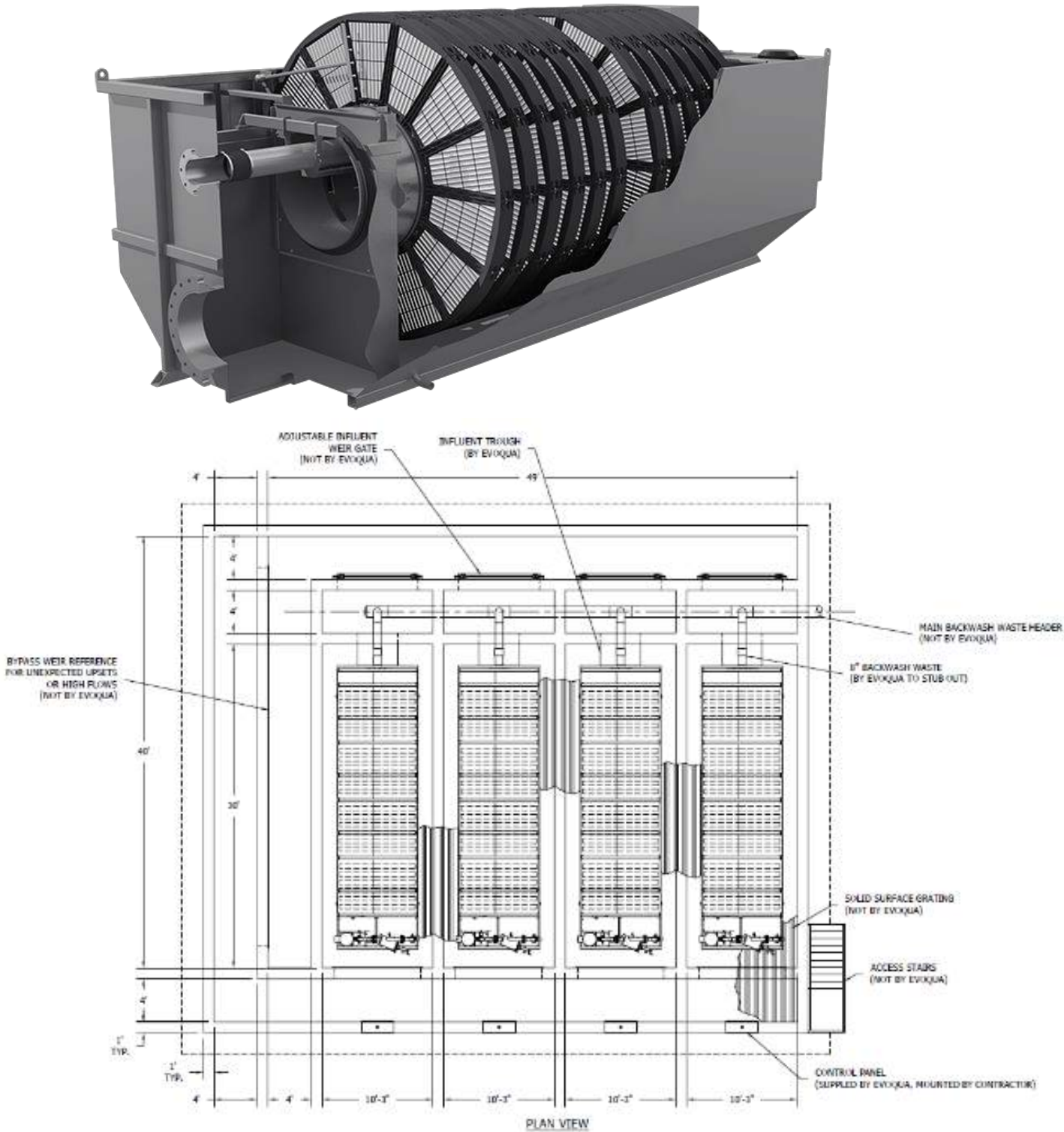

Figure 3-5
Five Star Filtration: Representative Filter Configuration

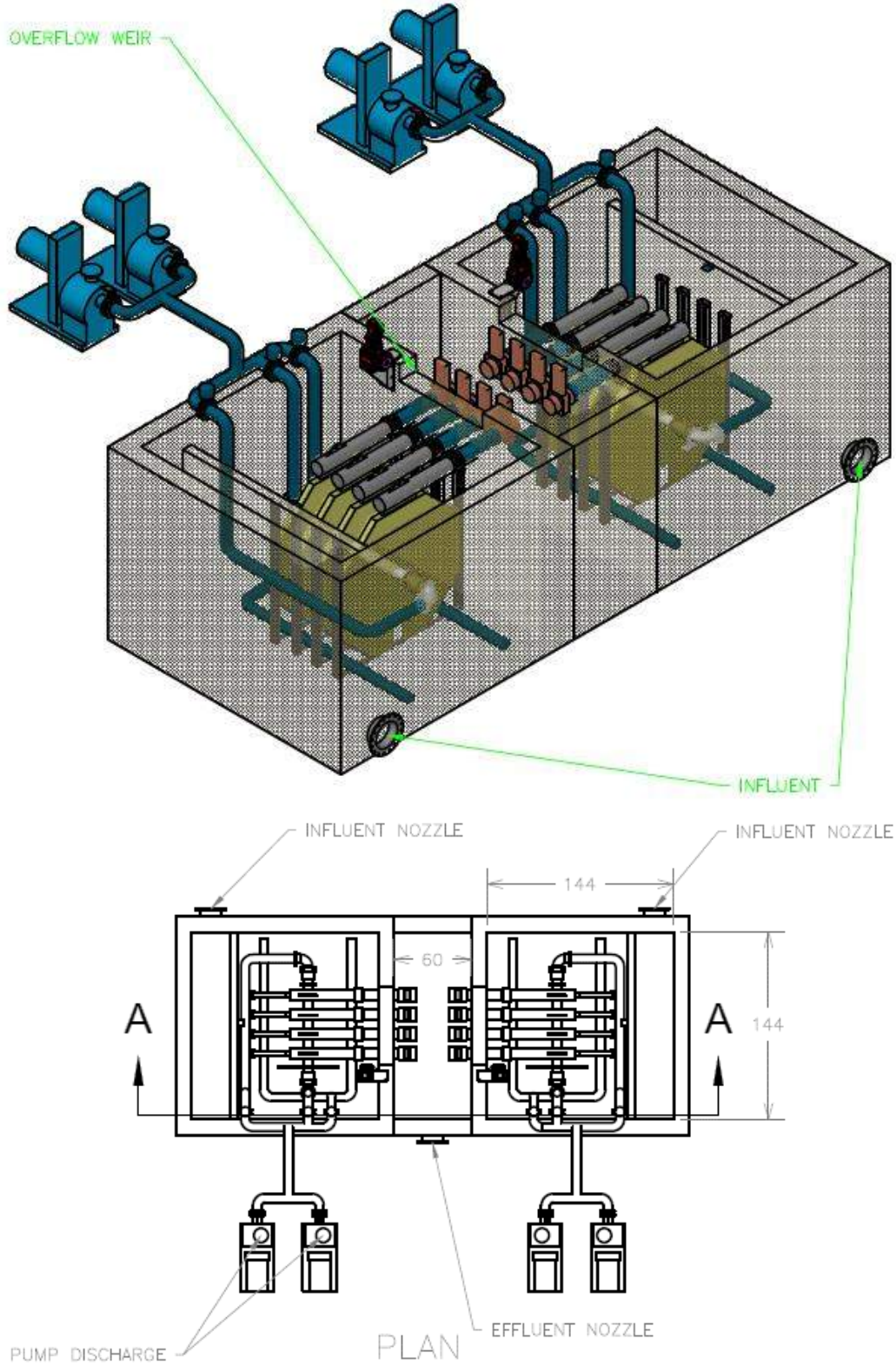
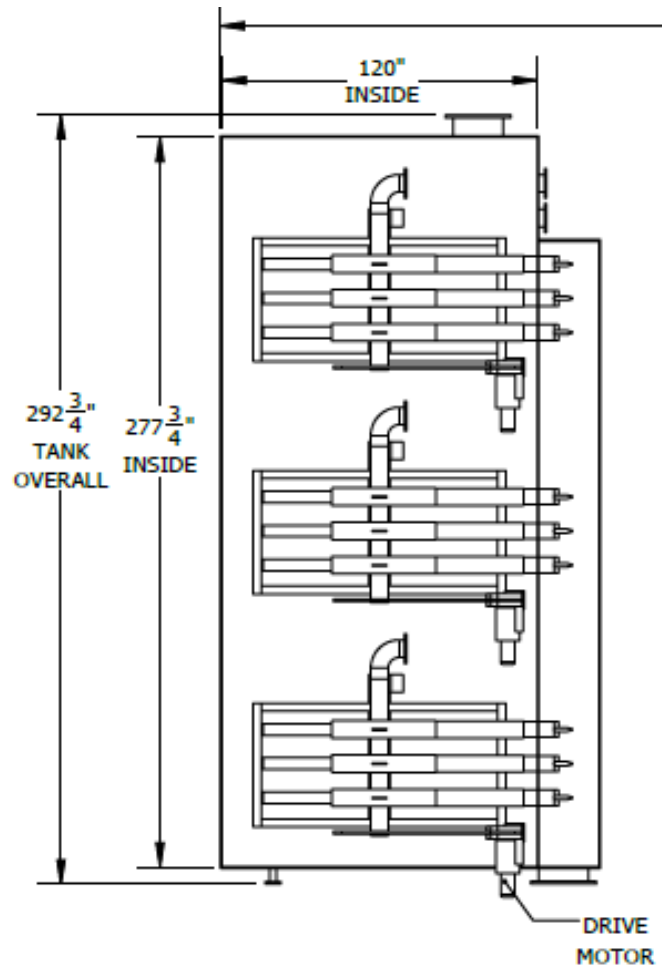
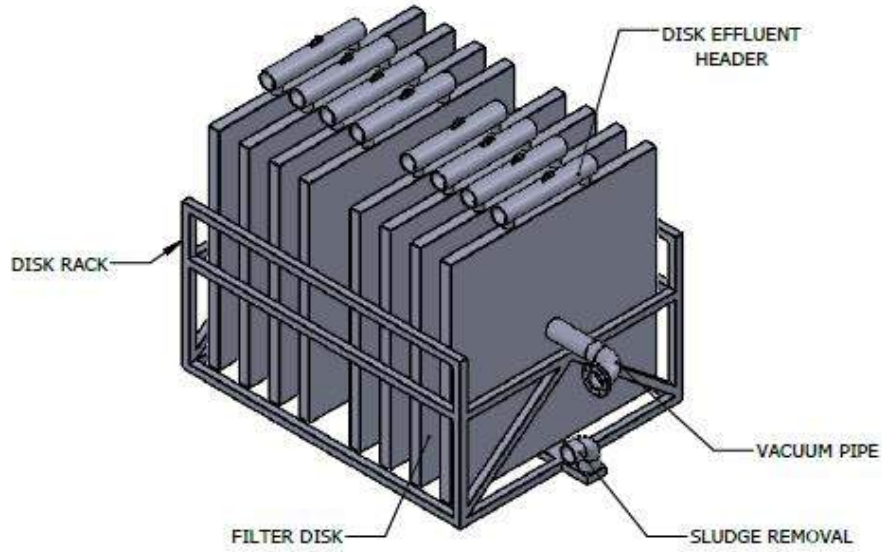

Figure 3-6
Nexom: Representative Filter Configuration



By evaluating the four solicited disc filter manufacturers, it was determined that while there are variances in their technologies largely driven by filter disc diameter, recommended loading rates and proposed piping configurations, there was sufficient commonality so that three of the four technologies using an outside-in flow pattern would fit into a common butterfly configuration. This configuration also closely matched preliminary layout and footprint requirements for the reuse pumping station. Accordingly, for the purposes of this study, a generalized filter model using the outside-in flow pattern was developed to facilitate conceptual site planning and hydraulic evaluation.

The fourth disc filter technology, manufactured by Evoqua, has an inside-out flow path and a much larger and shallower footprint by comparison. Evoqua was not further evaluated in this memorandum. At this time it is not recommended that inside-out technologies be excluded from consideration; but during detailed design and equipment preselection, the capital cost of a larger footprint and shallower filter cell can be considered concurrent with the technology. The generalized filter model is displayed in Figure 3-7.

The generalized filter layout includes an influent channel that directs water over influent weirs, before filling the filter cells. This butterfly layout allows filtered water to be collected in a combined effluent channel. Water then enters a forebay which provides a small amount of flow equalization and storage prior to effluent pumping. The layout is anticipated to minimize construction costs due to common wall construction of the influent channels, filter cells, forebay, and pumping station structure.

3.3.5 Reliability and Redundancy

UDWQ regulations do not require redundancy in the tertiary filtration process because secondary effluent can always be discharged via the current permit to the C-7 Ditch. Therefore, redundancy within the filtration system should be evaluated based upon reliability needs of the District for reuse water. Two primary reliability and redundancy proposals were solicited from each manufacturer.

The first option is a 2+0 split capacity configuration. This option comprised two filter cells in parallel that each treat 50% of the total influent flow. Fewer discs are required for treatment compared to full redundancy. However, in case of filter cell failure, only half of the influent capacity is available to be treated. A smaller initial footprint compared to the full redundancy option must be provided as each manufacturer only requires one extra disc to be added to each filter cell to treat buildout flow.

The second option is a 1+1 full redundancy configuration. This option comprised two filter cells in parallel with only one train required to operate at time. During normal operation, both filter trains would run (to keep the hydraulic and solids loading rates low and the cloth filters submerged). When one train is removed from service for maintenance or during an emergency, the remaining filter is designed to handle the entire influent flow rate. This option requires a larger footprint due to the increased number of discs needed to treat the influent flow. Each manufacturer also requires an additional 2-3 discs per filter cell to treat buildout flow conditions. This option has complete redundancy in case of filter failure. It also offers the ability to operate both cells in parallel (with sufficient electrical capacity available) to significantly reduce hydraulic loading rates in the event of upstream process upsets and avoid capacity reductions.

Table 3-4 summarizes the required number of filter discs needed by each manufacturer for each option and flow condition.

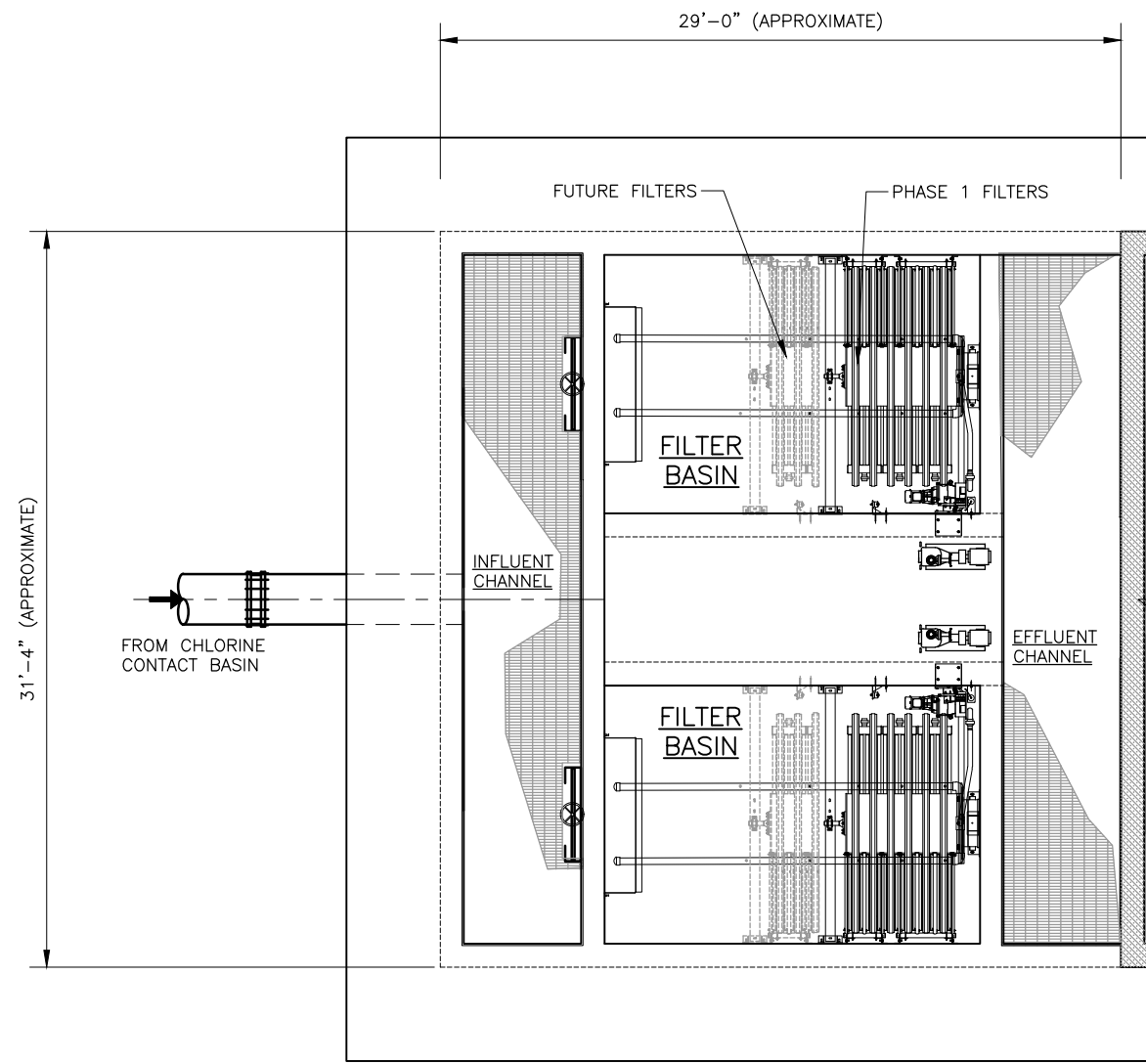

FILTER BUILDING – PLAN
SCALE: 1/4"=1'-0"

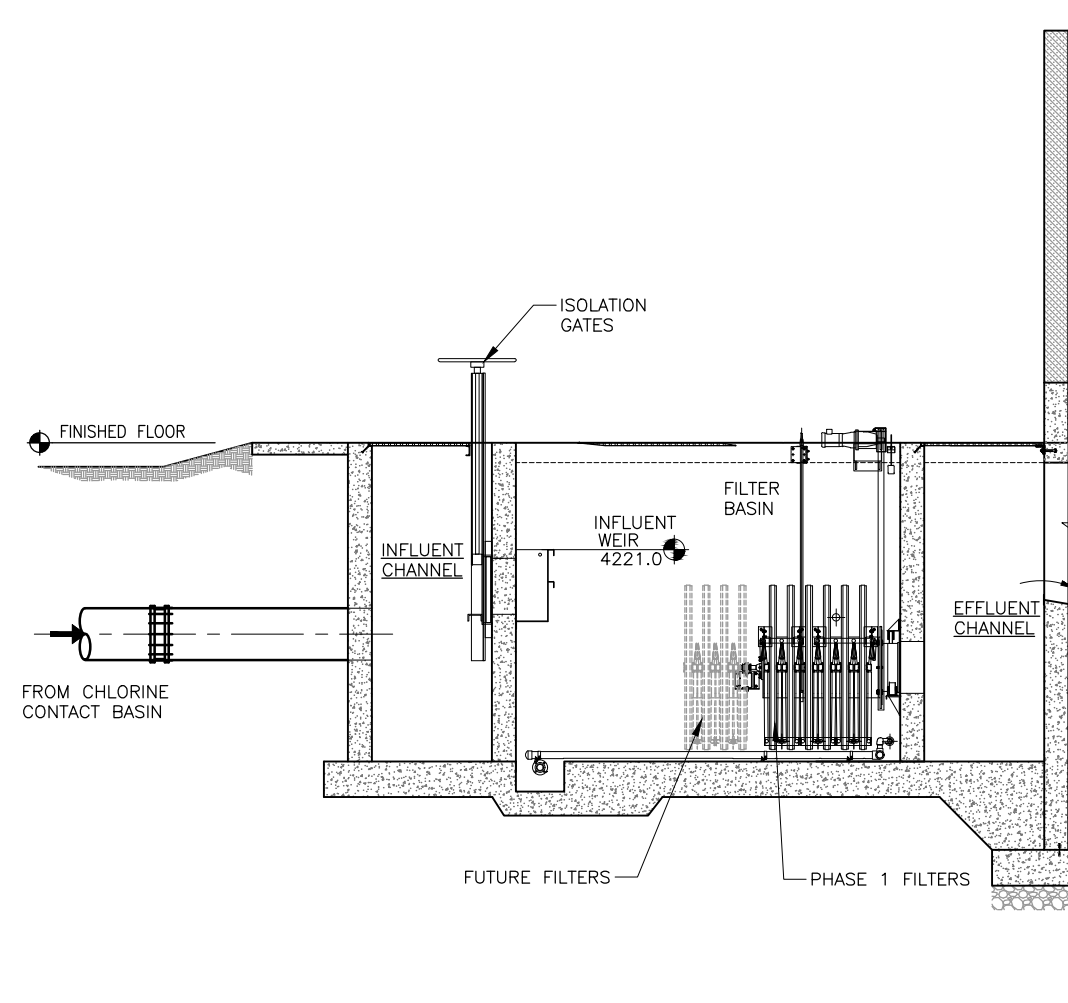

SECTION
SCALE: 1/4"=1'-0"

NOTES:

1. THIS DRAWING PROVIDES A CONCEPTUAL LAYOUT. FINAL DIMENSIONS AND LAYOUT WILL BE DETERMINE DURING FINAL DESIGN AND UPON SELECTION OF SPECIFIC MANUFACTURER.
2. BUILDING ENCLOSURE TO BE EVALUATED DURING FINAL DESIGN.



**Table 3-4
No. Discs Required per Train
by Filter Vendor and Configuration**

Manufacturer	Option 1: 2+0 Configuration	Option 2: 1+1 Configuration
Flow (mgd)	4.0 / 4.65	
Five-Star Filtration	4 / 5	8 / 10
Aqua-Aerobic	6 / 7	12 / 15
Nexom	4 / 5	8 / 10

It should be noted that both configuration options represent seasonal operation to match secondary system irrigation demands with the ability to execute preseason preventive maintenance and post season maintenance to ensure filter system reliability.

3.3.6 Proposal Summary and Analysis

Proposed information from the disc filter manufacturers for both configuration options are summarized in Tables 3-5 and 3-6. Full proposals for both options are include in the appendix.

**Table 3-5
Proposal Comparison for Option 1: 2+0 Configuration**

Manufacturer	Aqua-Aerobic	Five-Star Filtration	Nexom
Filter Model	2x AquaDisk ADFSC-54 x 6E-PC	2x FSDF-4D84DC	2x Infini-D Zero-Downtime 4-70
# of Units	2	2	2
# of Discs per Unit	6	4	4
Total Filter Area per Unit (ft ²)	323	288	286
Filter Loading Rate at PDF (gpm/ft ²)	4.2	4.7	4.7
Solids Loading at PDF (lb./ft ² /day)	1.01	Not provided	1.1
Backwash Pump	2 hp (130 gpm) (1 per unit)	2x 7.5 hp Wemco weir pump per unit	2x 10 hp (max) pumps
Electrical / Instrumentation Equipment	3 backwash valves, 1 solids waste valve, 1 level switch, 2 transmitters (vacuum and pressure)	4 backwash valves, 2 sludge valves, 2 level transducers	4 control valves and actuators, 2 pressure transmitters, 4 level switches

UDWQ requirements dictate a maximum filter loading rate of 5 gpm/sf for reuse purposes. The loading rates at peak daily flow for each manufacturer are reasonably similar and satisfy the UDWQ requirement. Five-Star Filtration and Nexom do not require as many discs as Aqua-Aerobic, which

reduces footprint requirements, but also places more demand on the system in case of disc failure or maintenance.

Table 3-6
Proposal Comparison for Option 2: 1 + 1 Configuration

Manufacturer	Aqua-Aerobic	Five-Star Filtration	Nexom
Filter Model	2x AquaDisk ADFSC-54 x 12E-PC	2x FSDF-8D84DC	2x Infini-D Zero-Downtime 8-70
# of Units	2	2	2
# of Discs per Unit	12	8	8
Total Filter Area per Unit (ft ²)	646	576	573
Filter Loading Rate at PDF (gpm/ft ²)	4.2	4.7	4.7
Solids Loading at PDF (lb./ft ² /day)	1.01	Not provided	1.1
Backwash Pump	2 hp (130 gpm) (1 per unit)	2x 7.5 hp Wemco Weir Pump per unit	2x 10 hp (max) pumps
Electrical / Instrumentation Equipment	6 backwash valves, 1 solids waste valve, 1 level switch, 2 transmitters (vacuum and pressure)	4 backwash valves, 2 sludge valves, 2 level transducers	6 control valves and actuators, 2 pressure transmitters, 4 level switches

The full redundancy configuration option requires twice the number of discs as the split capacity option and, consequently, a larger footprint. UDWQ effluent loading requirements of 5 gpm/ft² are still met by the manufacturers. The full redundancy option requires an increased amount of equipment and instrumentation, such as pumps and valves, compared to the split capacity.

Table 3-7 provides the common features for each filter cell by manufacturer.

**Table 3-7
Proposal Comparison for Common Features**

Manufacturer	Aqua-Aerobic	Five-Star Filtration	Nexom
Construction	Built into concrete basin (by others)	Built into concrete basin (by others)	Built into concrete basin (by others)
Flow Pattern	Outside-In	Outside-In	Outside-In
Maximum Filter Headloss (in)	8.8	12	24
Filter Type	304 SS materials	304 SS materials	304 SS materials
Filter Area per Disc (ft ²)	54	72	72
Cloth Type	OptiFiber PES-14 (5 micron)	1A (10 micron)	100% Polyester microfiber filter cloth
Backwash Cycles per Day	48	24	24
Backwash Cycle Duration (mins)	4	2.2	1
Drive Motor (hp)	0.5 (2+0) and 0.75 (1+1)	0.75	1
Control System	MicroLogix 1400 PLC	MicroLogix 1400 PLC	Allen Bradley PLC (1 per unit)
Control Panel	NEMA 4X Fiberglass	NEMA 4X Fiberglass	Not provided

The headloss that initiates backwash is different for each manufacturer. Five-Star Filtration performs more backwashes than the other manufacturers, which reduces the time that the filter cells are online for treatment. Each cloth type is chlorine resistant to any amount anticipated in the treatment system, as well as short-term higher concentration exposures. Type 304 stainless steel materials provide corrosion resistance. Control panels not installed indoors need to be weather resistant due to the nature of Utah's cold climate and snow/freezing events.

3.3.7 Equipment Cost Summary

Budgetary equipment costs are summarized for each filter cell configuration for three manufacturers in Figure 3-8.

**Figure 3-8
Equipment Budgetary Costs by Vendor and Configuration**

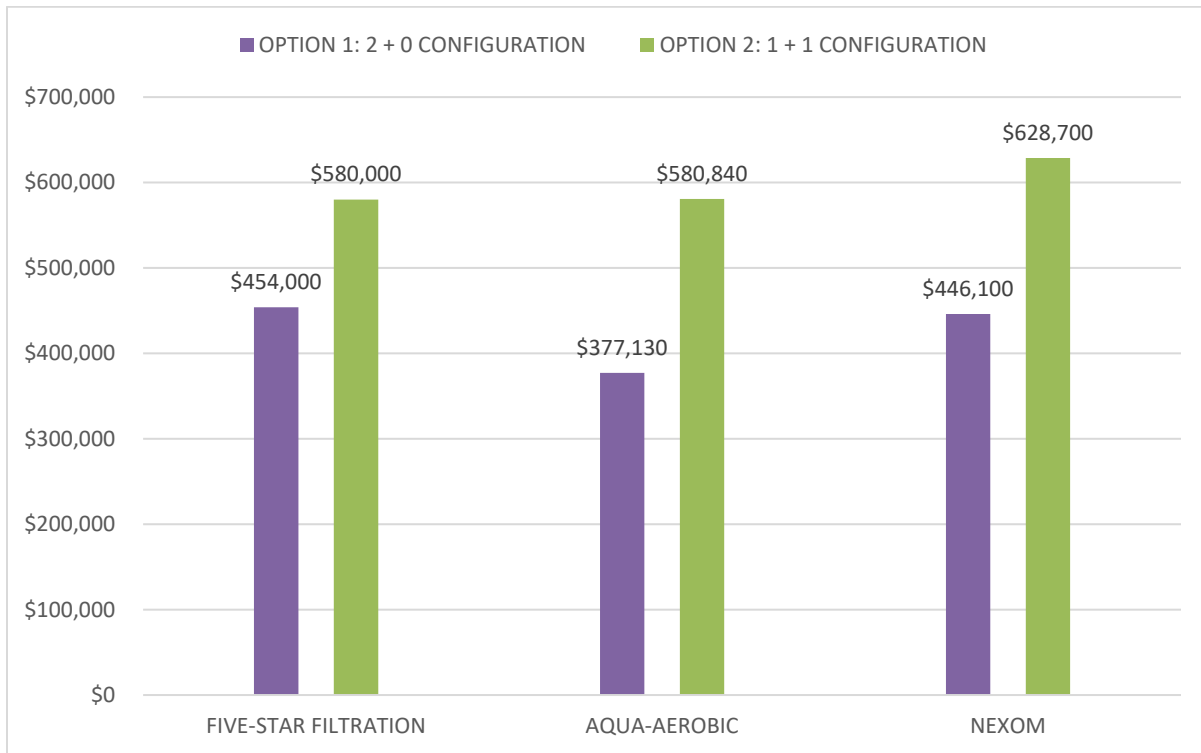

The presented figures include the cost of equipment only, with no capital costs included (piping, concrete, electrical, installation, etc.). These amounts are in development and will be provided as part of detailed design. Equipment costs between manufacturers do not markedly vary. Due to the smaller configuration and less required materials, the split capacity option is less expensive than the full redundancy option. The footprint of each configuration option is presented in Table 3-8.

**Table 3-8
Filter Cell Sizing by Configuration**

Option 1: 2+0 Configuration	Option 2: 1+1 Configuration
180 ft ² /cell	220 ft ² /cell

3.3.8 Discussion and Recommendations

During a workshop with the District in May 2021, the project team discussed filter options with particular emphasis on the reliability and redundancy configurations. Because the facility will only operate seasonally, and the cost of a 100% fully redundant train is significantly higher, the District elected to pursue Option 1: 2+0 Configuration. Under this option, a loss of one train would equate to a 50% reduction in reuse capacity.

There was also discussion of the duration of an anticipated outage. Filter manufacturers have identified the major risks of outage to be linked to the filter drive shaft mechanisms (motor and drive chains) and a loss of media integrity. With sufficient shelf-spares maintained onsite, manufacturers report that these outages were projected to be less than one day.

In the larger context of potential outages, we believe that water quality variability, process upsets, and pump and component failures should also be considered. In combination of these various factors, outages may require longer periods of downtime for service and repairs, approaching two weeks in our estimation.

With regards to process upsets and system optimization, none of the manufacturers identified a need for a coagulant or filter-aid polymer to consistently achieve proposed hydraulic loading rates or effluent turbidity. As a good design practice, it is recommended that the project retain the ability to dose pretreatment chemical, and that this need be further defined during detailed design.

It should be noted that Aqua-Aerobic elected to propose a hydraulic loading rate that was less than the maximum 5 gpm/sf allowed and did not consider a backwash cell as part of their active filtration area, while Five Star and Nexom both provided their equipment to the UDWQ maximum hydraulic loading and did not take into account the inability for a backwash cell to actively process flow. These issues will be further addressed during design, but for the purpose of this study, this was considered sufficient. However, in our experience with pilot testing and design of these systems, allowable loading rates and upstream treatment process performance significantly affect long term sustainable hydraulic loading rates. Accordingly, we recommend that further effort to validate and select an appropriate design hydraulic loading rate be pursued under detailed design.

3.4 DISINFECTION MODIFICATIONS

As discussed above, the overall approach to disinfection for this project is to utilize the existing disinfection system with modifications as needed in conjunction with new filtration facilities to satisfy UDWQ reuse criteria. This approach is summarized in the following paragraphs.

3.4.1 Concept

The District's chlorine disinfection facility is operated to provide an average effluent free chlorine residual of 0.7 mg/L. This operation results in an average *E. coli* in the final effluent of 9 organisms per 100 mL.

To satisfy Type 1 Reuse criteria, operation of the existing system will need to be modified to comply with a minimum effluent residual of 1 mg/L, and the combined reuse system will need to be operated to achieve *E. Coli* values of non-detect on a weekly median basis and 9 per 100 mL as a daily maximum. This will require an increased chlorine dose via existing plant infrastructure.

Additionally, it is recommended that an additional chlorine application point be provided at the reuse pumping station discharge to enable final chlorine residual trim as needed to provide a chlorine



EXISTING CREEK

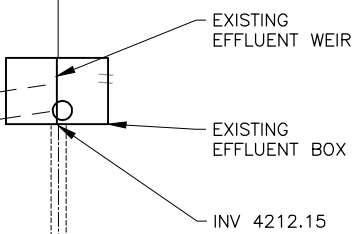

EXISTING 30" EFFLUENT PIPE_2

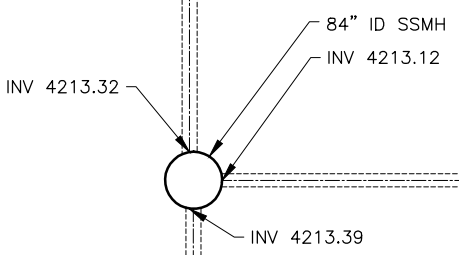

EXISTING 30" EFFLUENT PIPE_1



← INCREASED CHLORINE DOSE

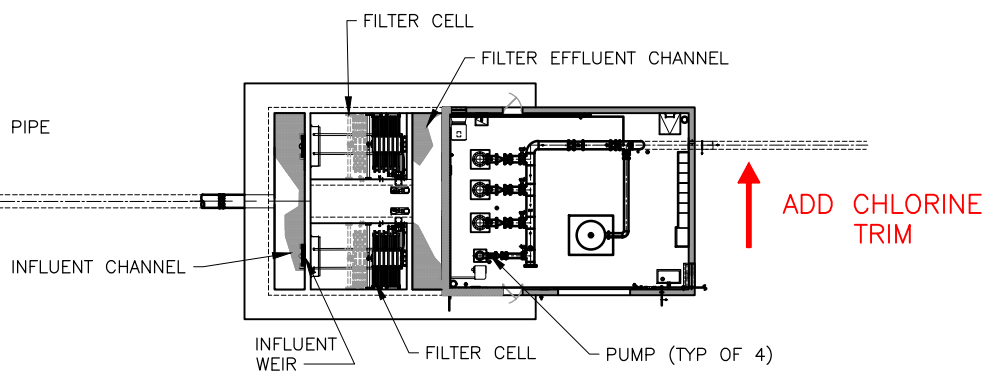

FILTER BUILDING AND PUMP STATION



MAGNA WATER DISTRICT
REUSE PROJECT PRELIMINARY ENGINEERING REPORT
DISINFECTION CONCEPT
FIGURE 3-9

residual for transmission to the secondary water system. Figure 3-9 depicts these system modifications.

3.4.2 Existing Facilities

Per the *Wastewater Facility Plan* (March 2017), the existing chlorination system has sufficient capacity to deliver a design chlorine dose of 25 mg/L at up to planned peak hour flows of 5.9 mgd. Per current practice, the District reported dosing of 1.2-1.5 mg/L to achieve current disinfection performance, and the system has the ability to scale up dose to meet the more stringent reuse requirements. The existing CCBs are sized to provide 30 minutes of contact time under maximum month design flow, which will also satisfy UDWQ criteria. Under average flow conditions, the CCBs provide 60 minutes of modal contact time.

A site tour was conducted on March 31, 2021 to review current plant condition and operations. During the visit it appeared that existing facilities continue to be in working order and suitable for use as a reuse disinfection system. Figures 3-10 and 3-11 (photos) depict portions of the existing system and their apparent visual condition.

Figure 3-10
Chlorine Contact Basin



Figure 3-11
Chlorinator, Storage Tanks, and Scale



During discussions with the District at the site visit, it was also learned that there is an existing set of eductors (Figure 3-12 – photo) and a two-inch pipe stub at the Chlorination Building that are not in use. It is proposed that this infrastructure be repurposed for the final chlorine trim at the reuse pumping station.

Figure 3-12
Existing Unused Chlorine Feed



3.4.3 Discussion and Recommendations

The existing chlorine disinfection system can be used largely as-is to satisfy reuse disinfection system requirements with increased chlorine dosages and minimal additional dosing infrastructure. It is anticipated that an increased chlorine dose can be delivered to achieve Type 1 *E. coli* standards based on observed historical performance.

After discussion it was agreed that bench scale testing would be performed to validate required chlorine dose with and without cloth media filtration (10 micron) to confirm operational requirements and provide insights for optimization of chlorine operating cost. This data will be used during design to ensure that reuse criteria can be satisfied.

It is anticipated, similar to current plant operations, that chlorine residual in effluent discharged to the C-7 Ditch will be consumed/dissipated prior to reaching Lee's Creek.

3.5 PUMP STATION EVALUATION

This section evaluates the proposed District reuse pump station for pumping treated effluent to the secondary water distribution system, including a hydraulic analysis of the pump station, phasing requirements, redundancy requirements, and conceptual pump station layout.

3.5.1 Pump Station Elevation Assumptions

The following elevation assumptions were used for this pump station evaluation effort:

- Pump station finish floor elevation = at existing grade (4,232 feet)
- Maximum wet well water surface elevation = 3 ft below grade
- Minimum wet well water surface elevation = 20 below grade

3.5.2 Hydraulic Analysis

The District's secondary distribution system hydraulic model was used to develop system curves for the proposed reuse pump station to pump treated effluent to the secondary water distribution system. Preliminary system curves based on system pressures are developed in Section 2, and those system curves were further explored in this analysis.

Three modeling scenarios were considered for evaluation of system curves for this proposed reuse pump station:

- Existing conditions (2020) with a peak design flow of 2.75 mgd (1,900 gpm).
- 20-Year conditions (2040) with a peak design flow of 4.00 mgd (2,800 gpm).
- 40-Year conditions (2060) with a peak design flow of 4.65 mgd (3,230 gpm).

System pressures obtained for these three scenarios from the hydraulic model were converted to total dynamic head (TDH), which is typically used for pump selection. The additional lift from the wet well water surface up to an at-grade pump station was factored into these system curves. For each of these three scenarios the TDH is different due to differing flow rates and the future completion of previously master planned secondary distribution system projects to resolve known system capacity issues as discussed in Section 2. Figure 2-13 shows the minimum and maximum system curves for the three scenarios based on TDH at the reuse pump station. The 150 PSI pressure

limitation for the secondary water system set by the District in Section 2 is acknowledged and maintained at 346.5 feet TDH.

**Figure 3-13
2020, 2040, and 2060 Reuse Pump Station System Curves**

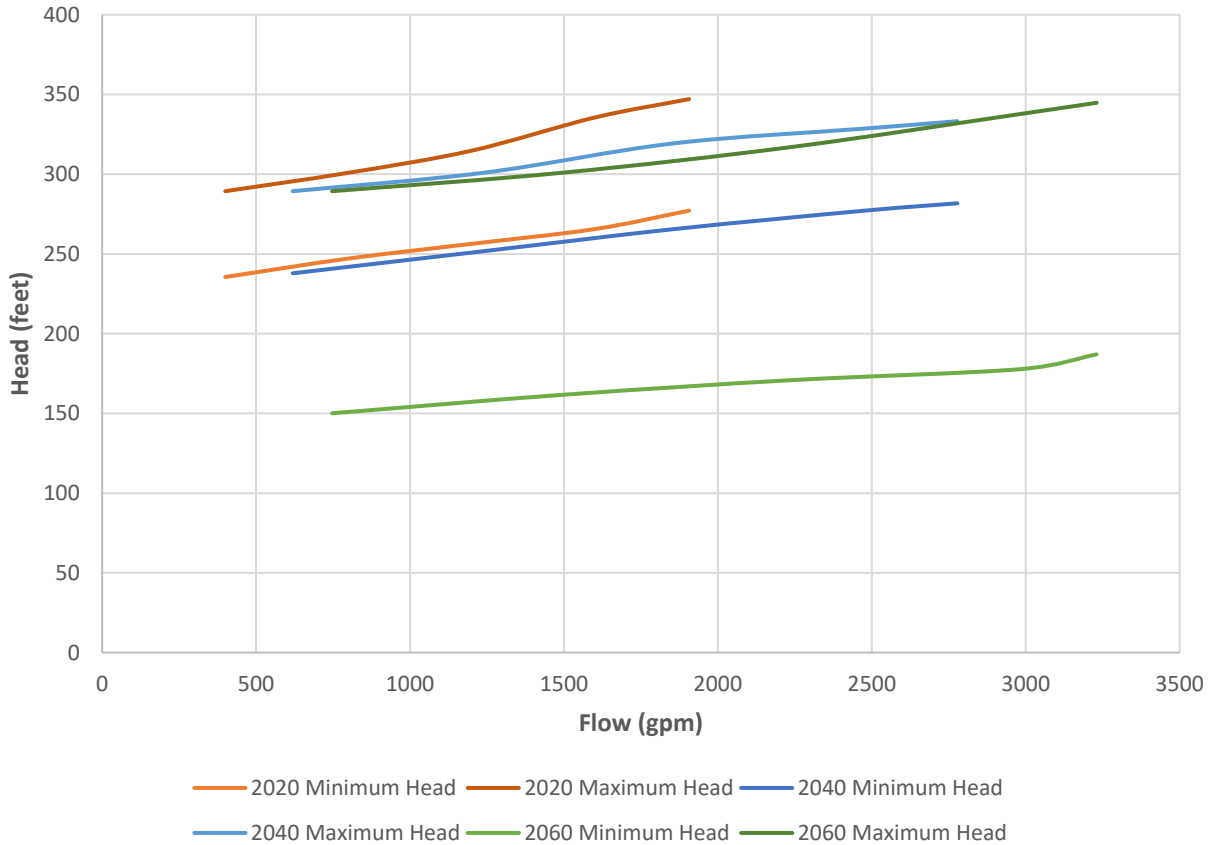

3.5.3 Pump Type Evaluation

Based on the required flow and head for this pump station, it was determined that the pump type best suited for the reuse pump station is multi-stage vertical turbines. Vertical turbine pumps are recommended due to their high efficiency, reliability, and ease of maintenance. The pump station is proposed to have a wet well installed under the pump station building to provide operational storage between the filters and the pumps.

Vertical turbine pumps enable the motor and pump controls to be located in a dry, at-grade pump station building with the pump column and bowls extending into the wet well below. This allows for direct pumping from the wet well and avoids any suction piping. Wet well sizing is discussed below.

It is recommended that the pumps in this reuse pump station be equipped with variable frequency drives (VFDs). VFDs will maximize operational flexibility needed to adjust flowrates to match seasonal fluctuation of reuse water demands and assist in maximizing reuse of WWTP effluent in the secondary system. Also, VFDs will enable the pumps to gradually increase or decrease the speed of the pumps to keep the flow rates through the reuse filters at relatively constant rates and to make

smoother flow rate adjustments rather than intermittent greater flow increases or decreases causing undesirable filter cycling.

3.5.4 Phasing and Redundancy Requirements

Phasing and redundancy requirements for the proposed reuse pump station were discussed with District staff. It was determined that the pumps would be sized based on the 20-year conditions flow of 4.00 mgd (2,800 gpm) and the rest of the equipment in the pump station (pipes, valves, electrical, etc.) would be sized based on the 40-year conditions flow of 4.65 mgd (3,230 gpm). Once the secondary system exceeds the 20-year design flow of 4.00 mgd or when the initial pumps reach the end of their operational life, the District can switch out those 20-year scenario pumps for larger pumps (40-year scenario) that have a maximum design flow capacity of 4.65 mgd.

Based on the design flow of 2,800 gpm and the system curves for the existing conditions and 20-year conditions, it was determined that the District would be best served by four total pumps in the reuse pump station, which are as follows:

- Pump 1 – 1,400 gpm design capacity (Large pump)
- Pump 2 – 1,400 gpm design capacity (Large pump)
- Pump 3 – 1,400 gpm design capacity (Large pump standby)
- Pump 4 – 550 gpm design capacity (Small pump)

Two of the large pumps running in parallel will meet the 2,800 gpm design flow requirement with a third large pump on standby for redundancy. As these three pumps are the same size, operational duty can be rotated between any two pumps with the third pump available to be taken out of service for maintenance. Due to much smaller secondary system demands between October and April, one smaller jockey pump is included for these time periods to handle the lower flow of 550 gpm, with a 50% turn down ratio on a VFD allowing low flows to extend down to approximately 275 gpm.

Data from the system curves was used to create operating ranges for the proposed pumping configuration which can be seen in Figure 3-14. This figure shows the proposed system curves and pump curves.

**Figure 3-14
2040 Pump Operating Ranges**

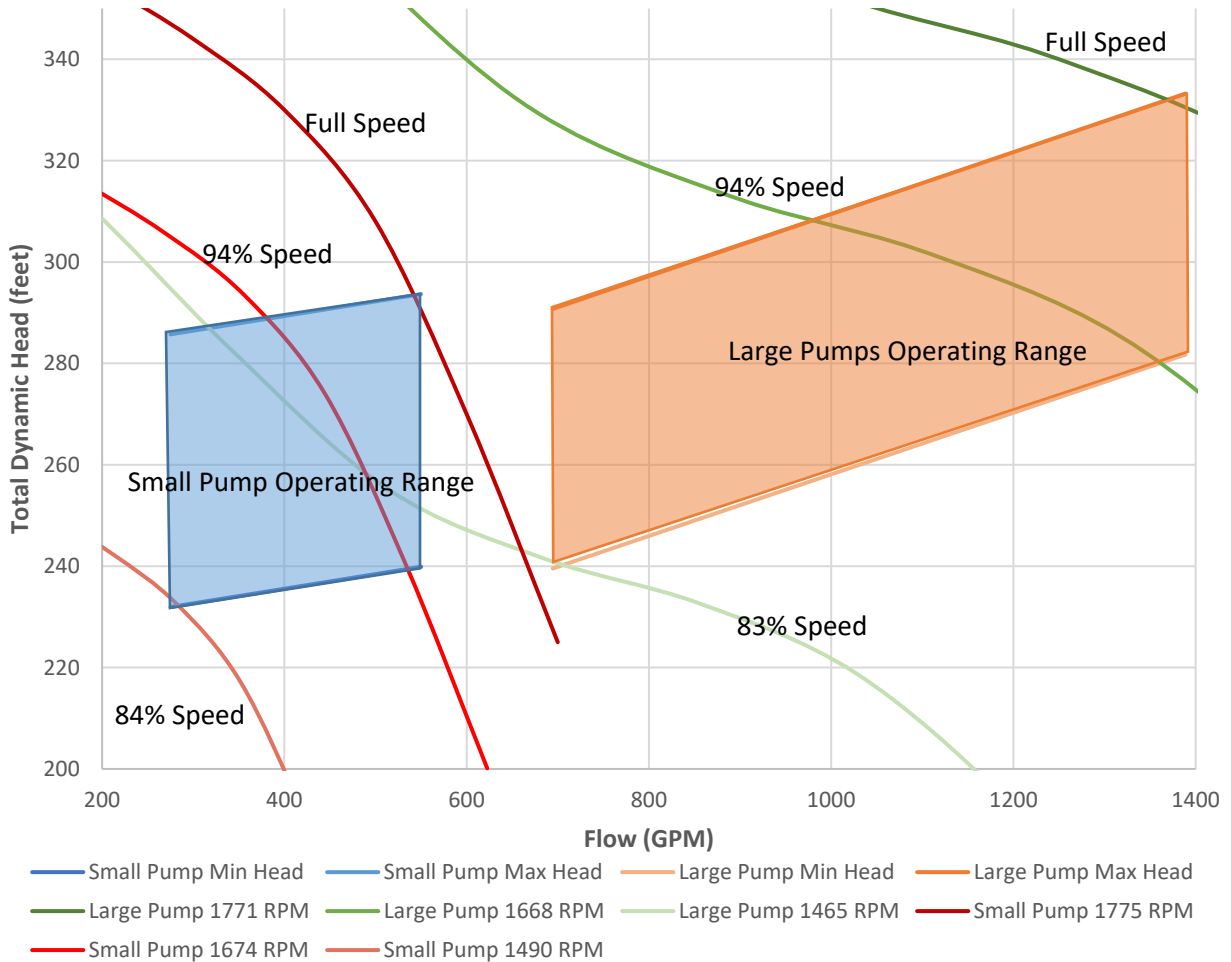

The proposed pump configuration provides a wide flow rate operational range and allows the pump station to adjust to anticipated changes in head in the secondary system. The VFDs would operate the pumps at ranges from full speed down to approximately 83% of full speed to meet the variable range of existing and future system curves.

3.5.5 Pump Station Horsepower Requirements

Based on the hydraulic analysis, phasing requirements, and redundancy requirements discussed above for the reuse pump station, horsepower requirements were determined for the 2040 (4.0MGD) and 2060 (4.65 MGD) scenarios, which are shown in Table 3-9.

**Table 3-9
Reuse Pump Station Horsepower Requirements**

Pump	Q (gpm)	Minimum Head (feet)	Maximum Head (feet)	Required Horsepower (motor)
Small Pump 50% Turn Down	275	232	286	-
Small Pump Full Capacity	550	240	294	60
Large Pump (2040) 50% Turn Down	695	240	291	-
Large Pump (2040) Full Capacity	1,400	282	333	200
Large Pump (2060) 50% Turn Down	808	151	290	-
Large Pump (2060) Full Capacity	1615	187	345	200

The combined motor horsepower of all 4 pumps is 660 HP (one 60 HP/small pump, and three 200 HP/large pumps). While the total pump equipment totals to 660 HP, only a maximum of 400 HP will be actively used at peak times when two, 200 HP pumps are used for peak pumping. This 400 HP maximum for active use is the case for both the 2040 (4.0 MGD) current pump equipment scenario and the future 2060 (4.65 MGD) pump equipping scenario.

3.5.6 Wet Well Sizing

Operational wet wells are typically sized for ½-1 hour of storage based on peak flow. Two options for wet well sizes at the peak 4.65 MGD scenario are shown in Table 3-10 for this range of storage times.

**Table 3-10
Wet Well Sizing Options**

Flow (gpm)	Time (minutes)	Volume (gallons)	Volume (CF)	Depth (ft)	Width (ft)	Length (ft)
3230	30	96,900	12,955	11	29.3	40
3230	60	193,800	25,909	15	29.3	59

As the secondary water system currently has the Zone 1 raw water reservoir to act as the primary system storage for the secondary water system, it was discussed with District staff that the reuse pump station wet well operation storage should be as small as feasible. Using the ½ hour operational storage time, and width and length selected to match the proposed pump station footprint, an approximate 11 ft. operation depth is calculated. Notice that the 11- foot depth indicated is not 11-

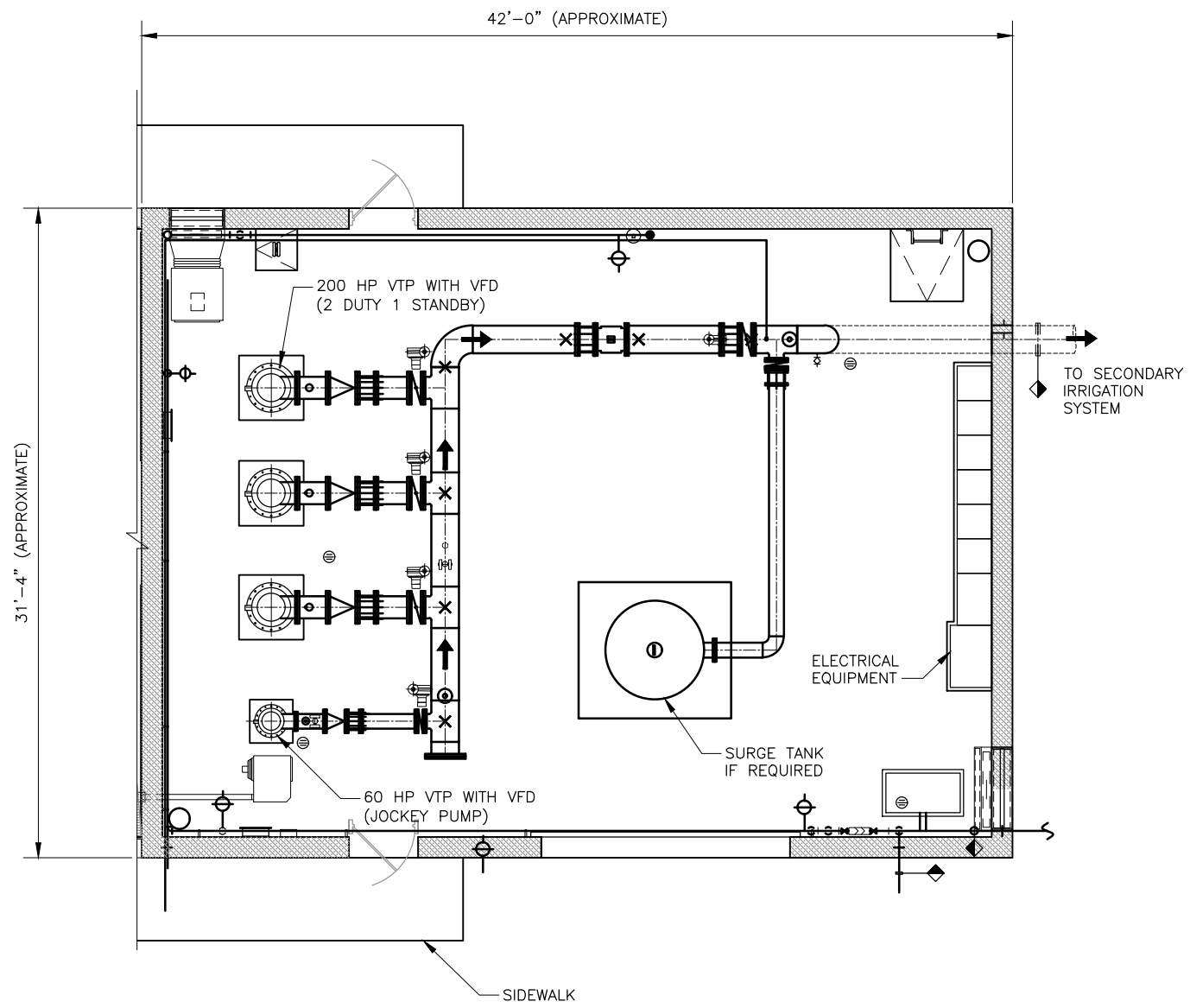

PUMP STATION – PLAN
SCALE: 1/4"=1'-0"

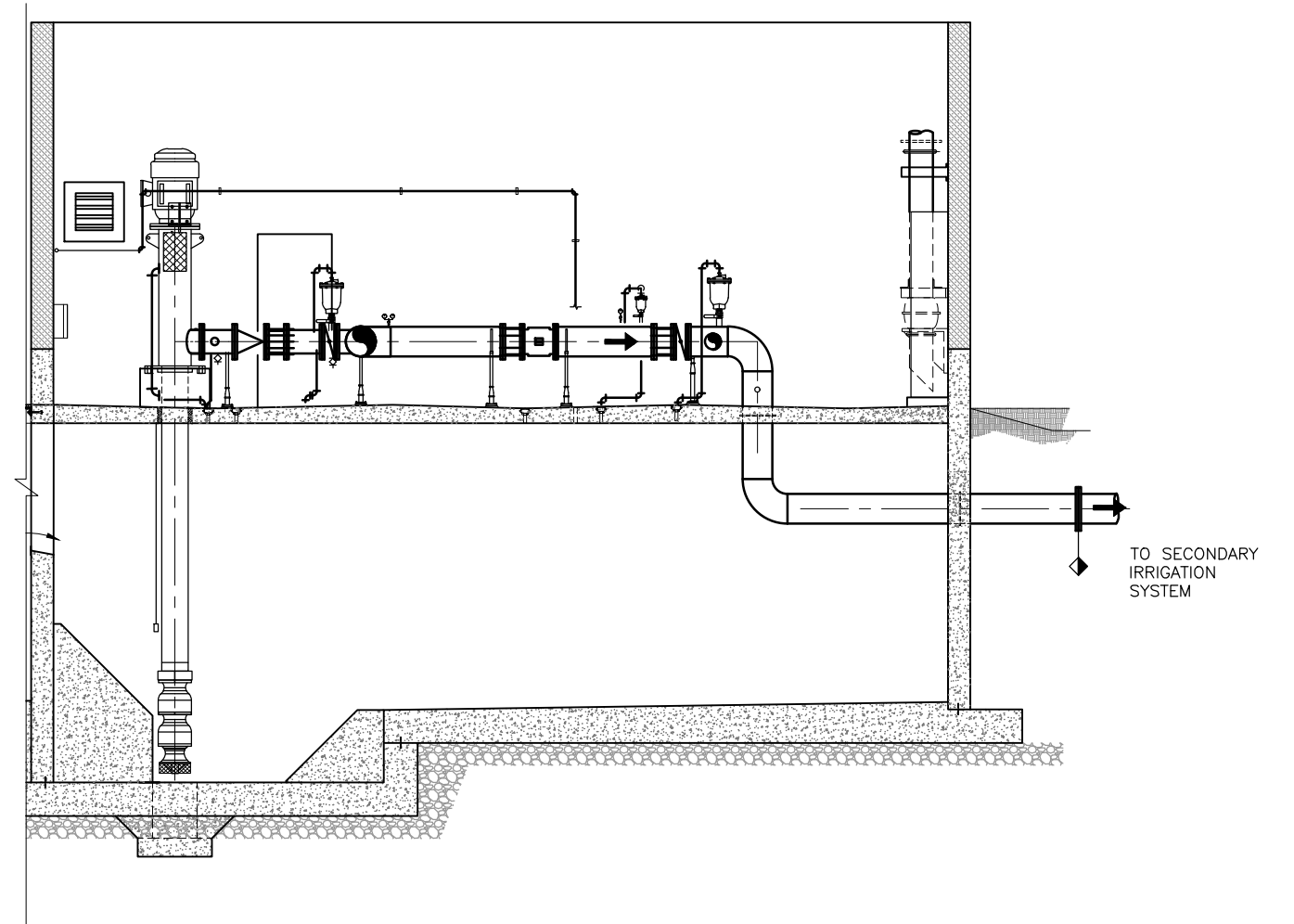

PUMP STATION – SECTION
SCALE: 1/4"=1'-0"



MAGNA WATER DISTRICT
MAGNA REUSE FACILITY
PUMP STATION - PLAN AND SECTION
FIGURE 3-15

feet from the ground surface but rather is an 11-foot operational depth below the water level discharging from the filter effluent channel and above the pump minimum submergence level. The 30-minute operation storage wet well sizing option is recommended to limit wet well depths and costs, and to coordinate wet well footprint sizing with the anticipated pump station structure footprint to allow for common wall construction.

3.5.7 Conceptual Pump Station Layout

A conceptual layout of the plan and section for the reuse pump station is illustrated in Figure 3-15. This figure shows the location of four pumps, the discharge piping header, a magnetic meter for flow monitoring, door and access locations, chlorine dosing locations, ventilation system, wet well general layout, and a potential surge tank if final design efforts determine it is needed. This conceptual site plan also identifies preliminary alignment for necessary yard piping including filter backwash connecting to the plant drain, chlorine trim from the existing chlorine building, and power from the existing electrical building.

3.6 HYDRAULIC REVIEW AND CONCEPTUAL SITE LAYOUT

An evaluation of overall proposed system hydraulics within the constraints of the existing plant hydraulic profile was performed and is summarized in the following paragraphs. Conceptual site planning was also performed and is presented below.

3.6.1 Hydraulic Profile Development

The existing plant hydraulic profile (excerpted in the appendix from the 1985 record drawings) was reviewed and a site visit was conducted on March 31, 2021 to validate current hydraulic performance against the original profile. All elevations discussed in this evaluation are based on the facility elevations from the original facility hydraulic profile and subsequent record drawings.

As discussed in Workshop No. 1 and above, the preference for managing reuse system hydraulics was to provide filter influent via gravity flow within the existing plant hydraulic profile rather than intermediate pumping. Accordingly, the reuse filters and pumping station are shown as a branched flow path in Figure 3-1 and Figure 3-9. In order to enable water to flow into this system by gravity, the design hydraulic grade line and water surfaces of the filters and filtered water forebay must operate at lower elevations than current plant facilities. The existing hydraulic profile shows that all chlorinated final effluent passes over a weir at 4,222.00 ft. elevation in the Effluent Box. At a future peak hydraulic flow of 6.6 mgd, the anticipated water surface elevation is 4,222.67 ft.

The utility water supply pumps at the Effluent Box pose an additional hydraulic constraint in that they must be provided water at an elevation suitable for their operation to avoid replacement or relocation.

3.6.2 Hydraulic Controls and Emergency Diversion

Three primary elements of hydraulic control are addressed herein: 1) filter hydraulics; 2) influent flow control; and, 3) emergency diversion capabilities.

Each of the filter technologies used in development of the generalized filter layout and hydraulic profile require use of a filter influent weir to control minimum submergence of the media during operation. This influent weir wall can prevent the filters from being drained in a backflow scenario, such as when the existing utility water pumps are operating.

Additionally, as there are two filter cells, influent weir gates are recommended to allow for isolation as needed for service. These gates can be used in either open/close isolation only or can be implemented with modulating actuators for incorporation into a filter influent flow control scheme.

Two filter influent control options were investigated, and each method is linked to provisions for emergency diversions as required by UDWQ requirements:

- A passive method that relies on filter hydraulics and filtered water forebay level control, and
- An active method that modulates to match filter influent flow to reuse pumping station discharge flow.

Both filter influent control schemes are presented in Table 3-11.

**Table 3-11
Filter Influent Control Options**

No.	Type	Control Point	Influent Gate Operation	Description	Discussion
1	Passive	Wetwell	Open / Close	Water will flow into Filters until Wetwell level rises above high setpoint, then backwater affect will begin reducing Filter Influent as Filter and Influent Channel WSE rises, diverting flow to Existing Outfall Box.	This option is the simplest base case and requires the least additional control components and complexity.
2	Active	Filter Influent Weirs	Modulating	Influent weir gates will modulate to restrict Filter Influent to match Reuse PS discharge.	This option offers the most active control and requires slightly more cost and controls complexity. One additional flow meter, modulating service actuators.

Both options utilize the same water surface design elevations and rely on rising water levels in the filter influent channel to control flow splitting between the reuse system and the existing plant outfall.

Under normal reuse operations, chlorinated secondary effluent will preferentially flow to the filters by design filter elevations and operational setpoints. As water level rises in the filter influent channel (whether by increased headloss in the filter cells, increased water level in the filtered water forebay, or by closing the influent weir gates) this flow will reverse direction and be discharged via the existing Effluent Box weir. Since this water has already been disinfected to reuse standards, it will satisfy existing discharge requirements without supplemental treatment.

Both options have been vetted with candidate filter technology manufacturers. The approaches are equivalent hydraulically, satisfy UDWQ criteria for emergency or off-specification water flow diversion, and may be refined during detailed design before final selection.

3.6.3 Model Methodology

A hydraulic simulation of the Magna Water District water reuse facilities was performed. The analysis focused on the impacts of downstream water surface elevations on flow split between the existing effluent box and the proposed water reuse filters. Different plant flows and flow split scenarios were modelled under preliminary assumptions. The model will be refined during detailed design phase.

Modeling was completed using Hydraulic Analysis and Design System (HADES) software. The model setup includes the existing chlorine contact basin (CCB) effluent box, the existing effluent pipe, the existing effluent box, the proposed influent pipe, and the influent channel of the proposed filter. It is assumed that a new manhole or diversion structure will be installed over the existing effluent pipe, approximately 15 ft east of the CCB effluent box to facilitate a new pipe connection for the proposed influent pipe. Elevations in the model were entered based on the *Magna Wastewater Treatment Plant Upgrade and Expansion 1985 Record Drawings*. Location of the proposed filter unit is preliminary and subject to change during detailed design phase. Pipe lengths were estimated from Google Earth imagery. Longer pipe lengths than measured were entered into the model for conservatism. All existing and proposed pipes were assumed to be of poor condition concrete, to yield larger head loss predictions. The simulation was performed assuming that all the flow is going through filter cell (Option 2: 1+1 Configuration) as the worst-case hydraulic model. The intention of these assumptions is to produce reliable and conservative concept modelling results.

3.6.4 Hydraulic Model Results

Hydraulic simulation results show that it is possible to convey treated effluent from the chlorine contact basin to the proposed filter unit through gravity flow. The flow split will occur inside the proposed manhole structure. Water surface elevations (WSEs) inside the existing effluent box (upstream of the effluent weir) and inside the filter influent channel (upstream of the influent weir) determine the flow split ratio. The effluent weir at the Effluent Box controls its upstream water surface elevation. There is no plan to update the existing Effluent Box structure. Therefore, the WSE at the Effluent Box cannot be manipulated. Different filter influent weir crest elevations were modeled to find the range of the WSE at the filter influent channel that will produce a flow split from 0 to 100% of the effluent flow from the CCB. Table 3-12 below shows the flow split based on the influent channel WSEs under two flow scenarios, the plant peak flow (6.6 mgd) and the minimum plant flow (0.6 mgd).

Table 3-12
Conceptual Flow Split by Design
Filter Influent Water Surface Elevation

Flow from CCB Effluent Box (mgd)	Flow to Proposed Filter (mgd)	Flow to Existing Effluent Box (mgd)	WSE at Filter Influent Channel (ft)	WSE at CCB Effluent Box (ft)
6.6	6.6	0	4221.75 max	4222.41
6.6	4.73	1.87	4222.20	4222.05
6.6	0	6.6	4222.90 min	4222.93
0.6	0.6	0	4221.95 max	4222.13
0.6	0	0.6	4222.20 min	4221.95

The above table shows that during a peak flow event, in order to let 100% of the effluent flow from the CCB reach the water reuse filter unit, the WSE at the influent channel cannot exceed 4221.75 ft. If the WSE at the influent channel is at 4222.90 ft or higher, then the filter unit will receive zero flow from the CCB. If the WSE at the influent channel is exactly at 4222.20, then 4.73 mgd of the 6.6 mgd will flow to the filter, and 1.87 mgd will flow to the existing effluent box. The flow split is more sensitive to the change in water surface elevations at the influent channels if the total flow is smaller.

The weir crest elevation at the existing CCB effluent box is 4223.35. The highest WSE at the CCB effluent box downstream of the weir occurs when 100% of the plant peak flow (6.6 mgd) flows to the existing effluent box. That WSE is at 4222.93 ft as shown in the table above, which is lower than the CCB effluent box weir crest elevation. Therefore, the existing CCB effluent weir will never flood. No modifications are needed to the existing CCB structure.

The minimum water surface under all scenarios appears to be sufficient to provide submergence at the existing utility water pumps so modifications to that system are not anticipated. Figure 3-16 presents an overall conceptual hydraulic profile based on this evaluation.

3.6.5 Conceptual Site Layout

The evaluation of the best location for the reuse pump station was straightforward since the pump station must be constructed so that it lies between the existing chlorine contact basins and the existing secondary reuse discharge pipeline. Figure 3-17 shows the conceptual site plan for the reuse pump station. The existing chlorine contact basins are shown on the northwestern side of the proposed reuse pump station site, and the existing secondary reuse discharge pipeline are shown to the south of the proposed reuse pump station site.

3.7 CONCLUSIONS AND RECOMMENDATIONS

Major conclusions and recommendations contained in this section are summarized as follows:

1. The filters will be installed in concrete basins to ensure gravity flow compatibility with the existing plant hydraulic profile.
2. Filter preselection should be performed during detailed design to allow for manufacturer specific efficiencies in sizing and layout configuration.

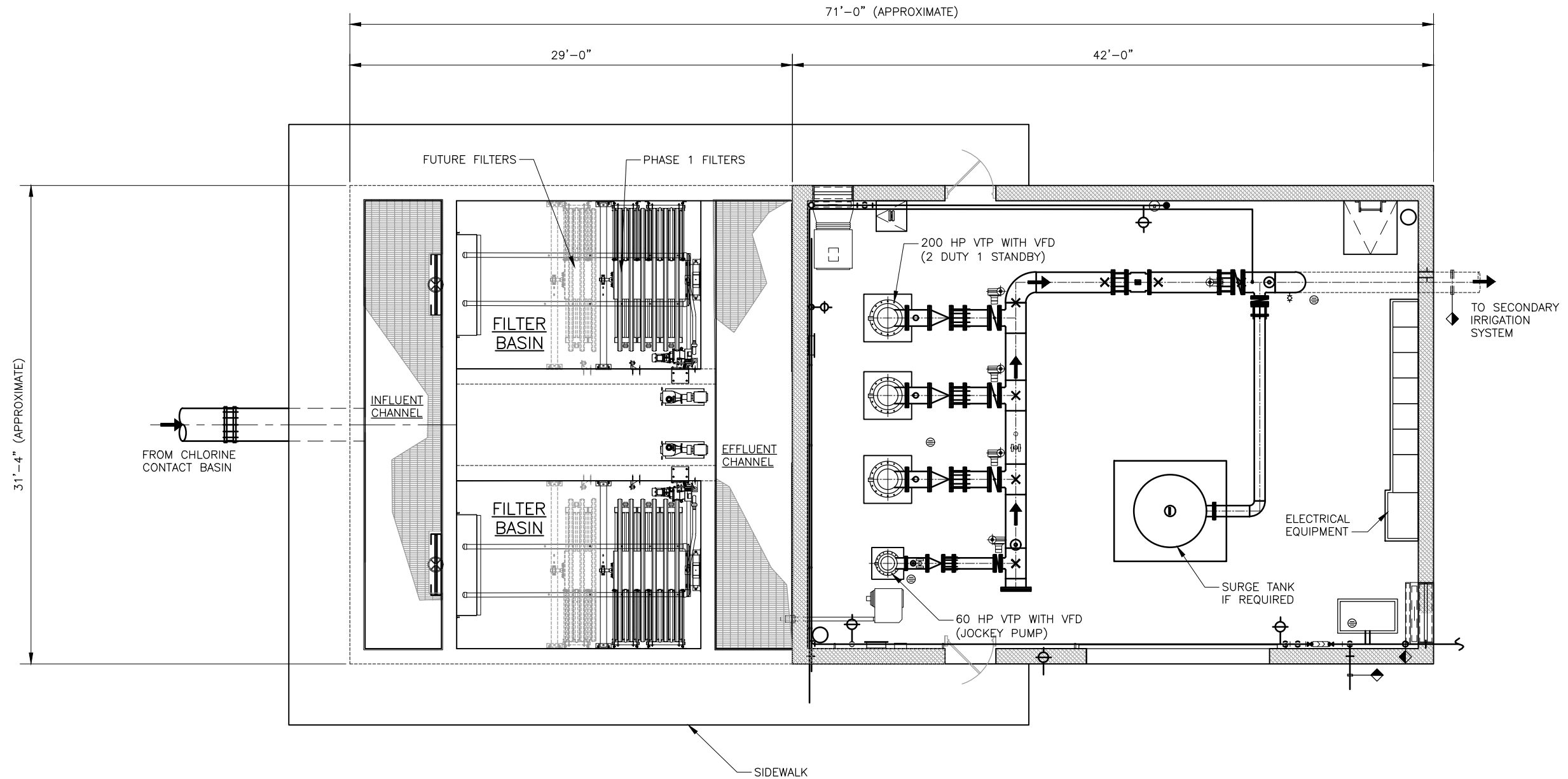

FILTER BUILDING AND PUMP STATION – PLAN
 SCALE: 1/4"=1'-0"



MAGNA WATER DISTRICT
 REUSE PROJECT PRELIMINARY ENGINEERING REPORT
FILTER BUILDING AND PUMP STATION
 FIGURE 3-18

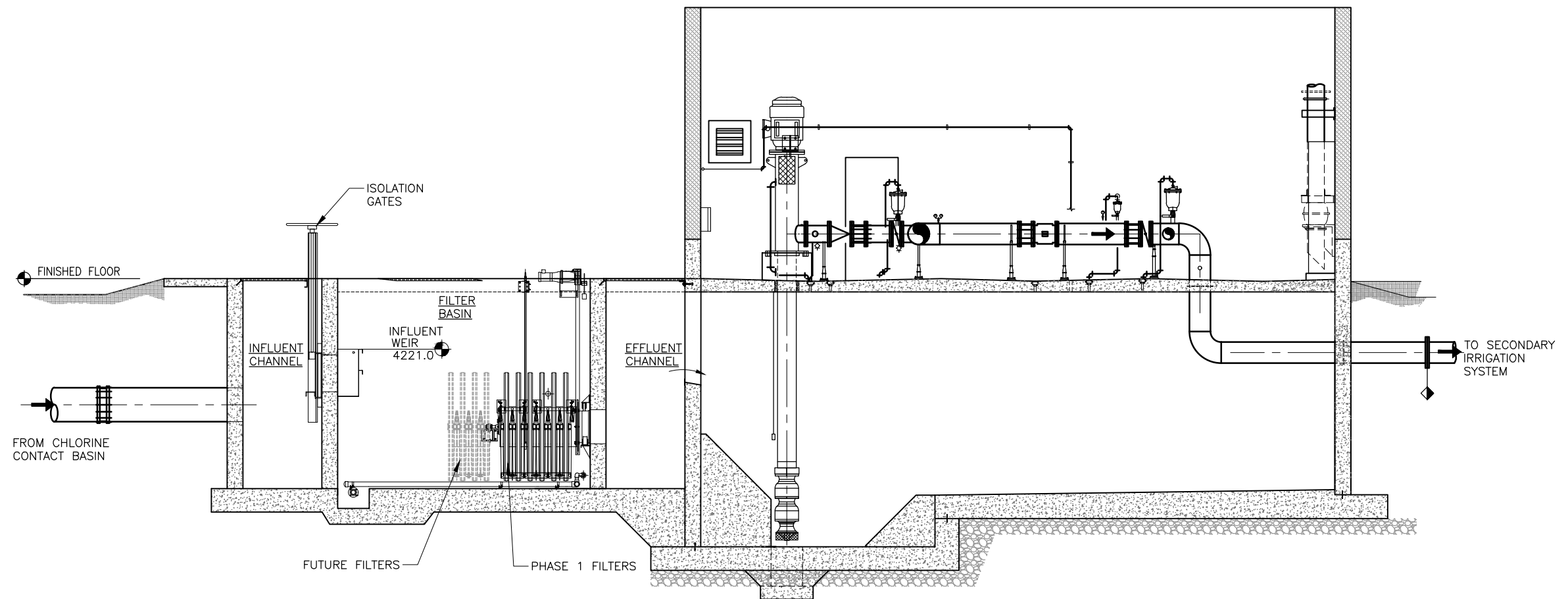

FILTER BUILDING AND PUMP STATION – SECTION
 SCALE: 1/4" = 1'-0"



MAGNA WATER DISTRICT
 REUSE PROJECT PRELIMINARY ENGINEERING REPORT
FILTER BUILDING AND PUMP STATION
 FIGURE 3-19

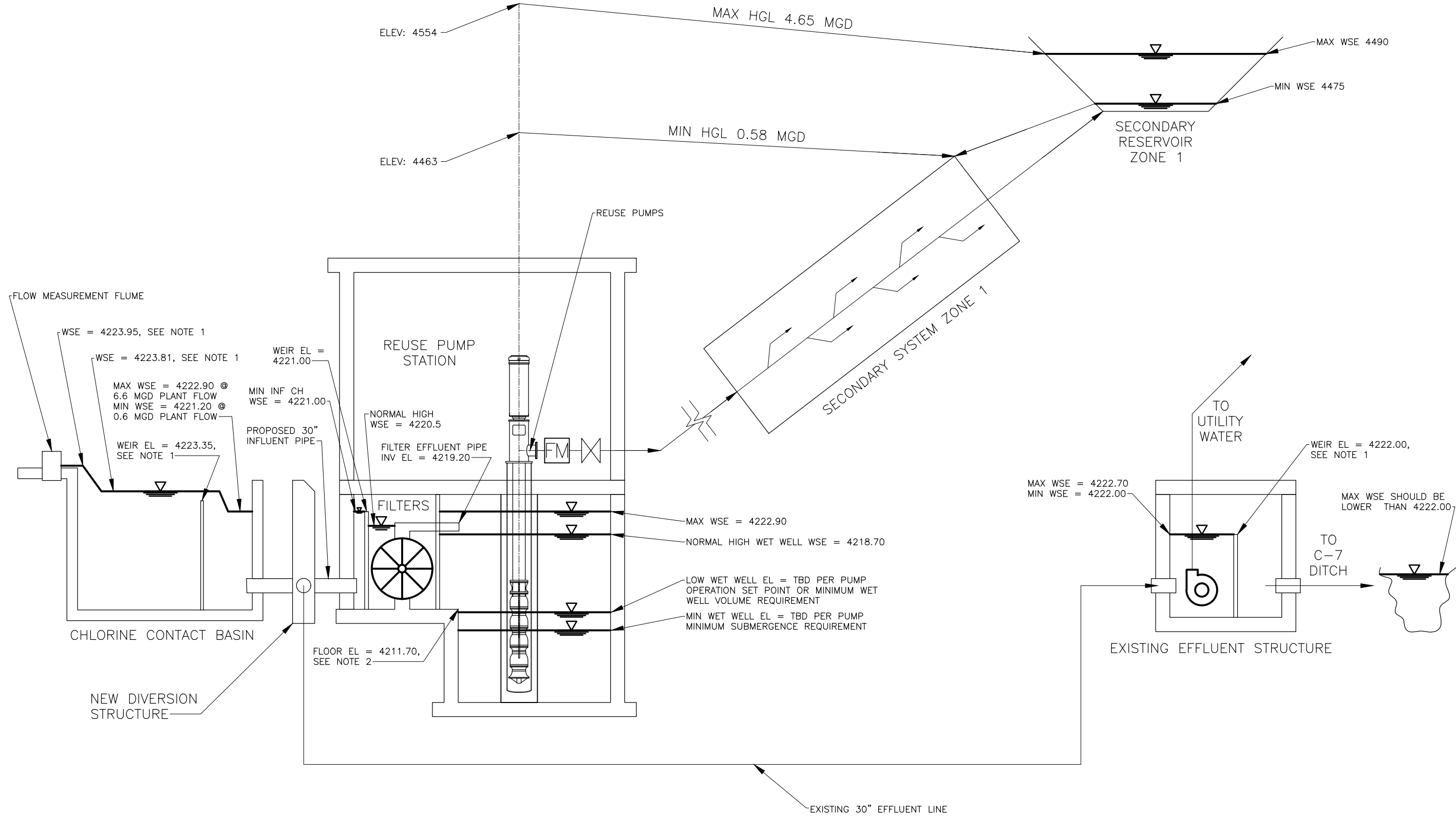

- NOTES:
- ELEVATION SHOWN IS BASED ON THE HYDRAULIC PROFILE (G-4) FROM MAGNA WWTP 1985 RECORD DRAWINGS.
 - FLOOR ELEVATION IS CALCULATED BASED ON FILTER UNIT PROFILE PROVIDED BY THE MANUFACTURER (COOMBS HOPKINS)



MAGNA WATER DISTRICT
 REUSE PROJECT PRELIMINARY ENGINEERING REPORT
HYDRAULIC SUMMARY
 FIGURE 3-16

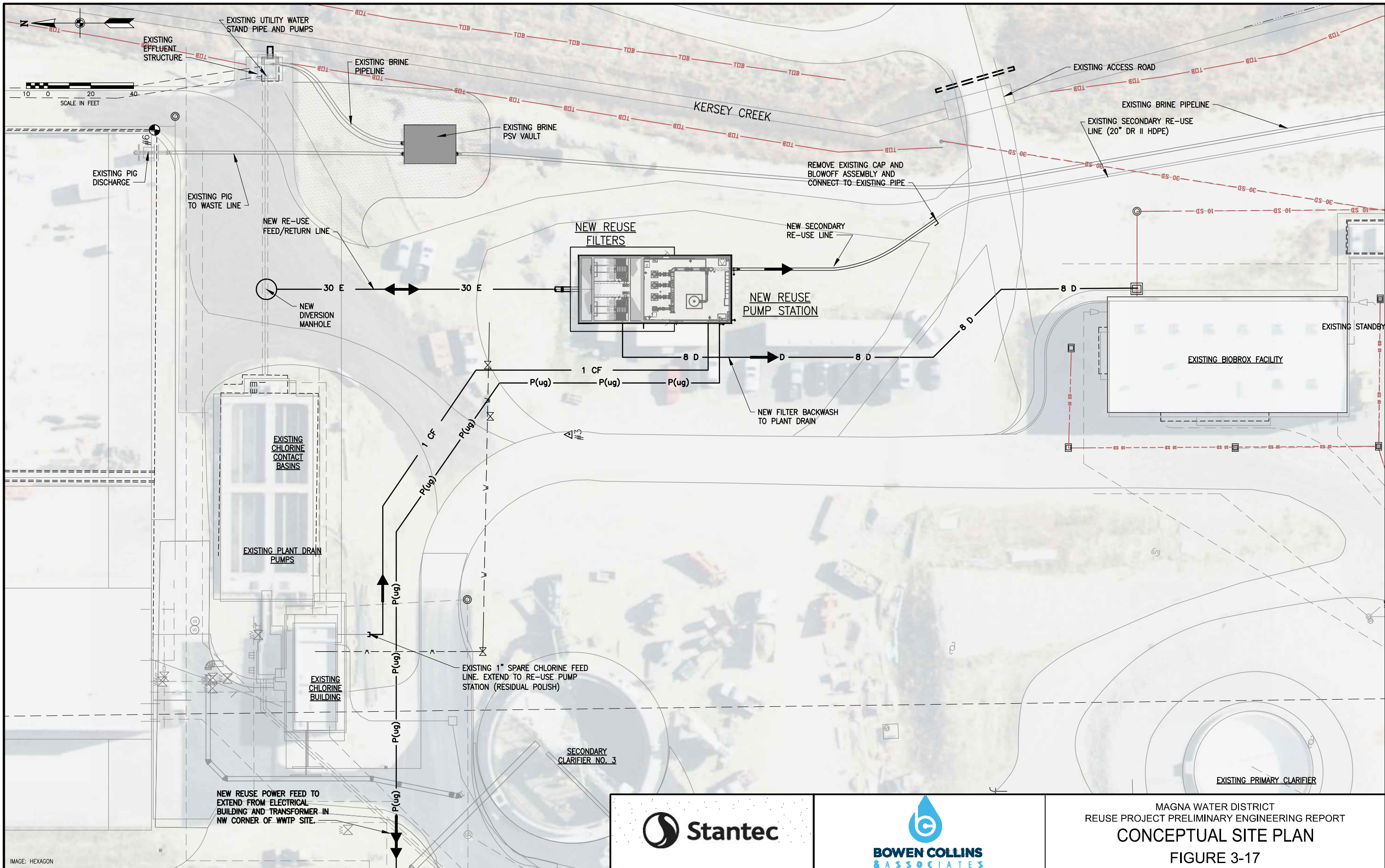

MAGNA WATER DISTRICT
 REUSE PROJECT PRELIMINARY ENGINEERING REPORT
CONCEPTUAL SITE PLAN
 FIGURE 3-17

3. Option 1: 2+0 filter configuration is preferred for a basis of design due to the smaller footprint and acceptable level of redundancy for seasonal operation.
4. It is recommended that feeding a pretreatment chemical (either a coagulant or filter aid polymer) be considered in detailed design if needed to ensure reliable operation.
5. It is recommended that further effort to validate and select an appropriate design filter hydraulic loading rate be pursued under detailed design if needed.
6. The existing chlorine disinfection system can be used largely as-is to satisfy reuse disinfection system requirements, with increased chlorine dosages and minimal additional dosing infrastructure.
7. It is recommended that an additional chlorine application point be added at the reuse pumping station discharge to allow for final chlorine residual trim as needed to provide a chlorine residual for transmission to the secondary water system.
8. Existing unused chlorine dosing equipment and piping stubs can be repurposed for use as an additional dosing point at the reuse pumping station.
9. It is recommended that bench scale testing be performed to validate required chlorine dose, with and without cloth media filtration (10 micron) to validate operational requirements and provide insights for optimization of chlorine operating cost.
10. It is feasible to convey treated effluent from the chlorine contact basin to the proposed filters through gravity flow, without modifications to either the existing CCBs or Effluent Box.
11. It is recommended that filter influent flow control be via passive methodology.
12. It is recommended that emergency flow diversion as required by reuse regulations be managed by flow reversal in the filter influent line and discharge via the existing Effluent Box.
13. Pump type is recommended as vertical turbine pumps to maximize efficiency and operational and maintenance access. VFDs are recommended on each pump to enable flows to be adjusted to match seasonal variations secondary system demands and changes in available WWTP effluent water for reuse.
14. The pump station features such as pipelines, wet wells, electrical equipment, and valves have been sized for the future year 2060, 4.65 MGD scenario. The pumps are recommended to be currently equipped for the year 2040, 4.0 MGD scenario at this time. The District will have the ability to upsize the pumps to meet the 4.65 MGD scenario in the future.
15. The pump station is recommended to be equipped with 4 total pumps. Three identically sized, 200 motor HP pumps would operate for most of the irrigation season, with one or two pumps on duty and one in standby (2+1). This provides for 50% pumping redundancy at peak flow. A smaller jockey pump (60 motor HP) is recommended to pump during times when irrigation demands are much lower in the early spring and late fall. Use of the smaller pump in low demand portions of the season will prevent excessive cycling of the larger pumps, wet well and filters outside of peak irrigation season.
16. The 4-pump operational scenario requires 660 motor HP in total pumps equipped with a maximum of 400 motor HP operational at any given time at peak flow.
17. Wet well sizing to provide a ½ hour operational storage at peak flow with a wet well footprint matching the proposed pump station would require an 11ft. operation wet well depth.
18. Figures 3-18 and 3-19 illustrate a conceptual layout and section for the Magna Reuse Facility based upon the findings within this section.

SECTION 4 – REUSE PLAN SUPPLEMENTAL DOCUMENTATION

4.1 INTRODUCTION

A Reuse Plan must be submitted to and approved by the UDWQ prior to utilizing treated effluent within a secondary irrigation system. Requirements of the Reuse Plan are outlined in Utah R317-3-11. The intent of this section is to address requirements of the plan that are not specifically covered in the other sections.

4.2 NUTRIENT MANAGEMENT AND AGRONOMIC UPTAKE

The term “agronomic rate” used in this study refers to precise amounts of water and nutrient loading, which turf grass requires for healthy growth without excess water or nutrient penetrating beyond the root zone. Application beyond turf grass requirements can result in effluent penetrating below the root zone and eventually into the ground water system. Areas to be irrigated with Magna WWTP reuse water will generally be landscaped with turf grass. The following sections summarize agronomic nutrient requirements and irrigation water requirements for turf grass.

4.2.1 Agronomic Nutrient Requirement

The rate at which nutrients can be applied to a particular crop or vegetation is based in part on the characteristics of local soils. It is imperative that excess nitrogen or phosphorus not accumulate in soil. Excessive nitrogen can cause groundwater contamination and excessive phosphorus can contaminate surface water. Nutrient application rates can most accurately be assessed after the performance of a soil phosphorus test, but unless there has been a history of heavy application of manure or inorganic phosphorus fertilizers in recent years, it is unlikely that soil phosphorus levels will dictate agronomic application rates. In this situation, the agronomic application of nitrogen becomes the determining factor for the rate of application⁴.

Agronomic Uptake of Nitrogen. Nitrogen exists in several forms in the effluent of the Magna WWTP including organic nitrogen, ammonia nitrogen, nitrite, and nitrate. Total Kjeldahl Nitrogen (TKN) tests provide the concentration of both organic and ammonia nitrogen. It is important that concentrations of each form of nitrogen be considered due to their unique characteristics and effects on agronomic rate calculations. Table 4-1 contains the relative levels of each of the nitrogen compounds in the effluent of the Magna WWTP derived from data provided by the District.

⁴ Land Application of Biosolids, A Guide for POTW Operators, Utah State University Cooperative Extension, Table 1

**Table 4-1
Magna WWTP Nitrogen Fractions in Effluent**

	Ammonia/ Ammonium NH₃+NH₄ (mg/L)	Nitrate+Nitrite NO₃ + NO₂ (mg/L)	Total Kjeldahl Nitrogen (mg/L)
Average	1.4	9.6	2.5
Max	3.3	17.9	4.8
Min	0.2	1.9	1.0

According to the Utah State University Extension, nitrogen is the most important nutrient in developing thick, healthy turf grass. Soil test summaries in the Salt Lake City area have shown that 90 percent of lawn samples are high or very high in phosphorus. Potassium is also usually adequate in native soils for lawn grasses. Therefore, nitrogen is often the only fertilizer element needed unless a soil test specifically shows a deficiency of phosphorus or potassium. For healthy turf grass in northern Utah, one pound of nitrogen should be applied to each 1,000 square feet of grass every four to six weeks⁵.

Based on an application rate of 1.0 lb./1,000 ft², 43.6 pounds of nitrogen should be applied to each acre of turf grass every four to six weeks during the growing season. If nitrogen is applied at the recommended intervals, then approximately 200 pounds of nitrogen will be applied per acre over the course of the growing season depending on whether 4-week or 6-week application intervals are used. For this study, the 6-week application interval and associated 200 pounds per acre nitrogen application rate are used.

Utilization of Effluent Nitrogen. Not all nitrogen in the Magna WWTP effluent is available to meet agronomic demands. A portion of Ammonium-N (NH₄) is readily transformed and is lost as a gas. For preliminary calculations it is estimated that 50% of ammonium is available, and the remaining 50% is volatilized and lost⁶. By subtracting effluent ammonia from the effluent TKN, organic nitrogen content can be calculated. Organic nitrogen must go through a mineralization process before it can be utilized. For preliminary calculations it is estimated that 30% of the organic nitrogen is available for uptake⁷. One hundred percent of nitrite and nitrate (NO₂ and NO₃) are available as a fertilizer for plants.

Table 4-2 shows each of the forms of nitrogen found in the Magna WWTP effluent, their average concentrations and the equivalent pounds per one million gallons of effluent.

5 Fertilizing Lawns, Larry Sagars, Utah State University Extension

6 Land Application of Biosolids, A Guide for POTW Operators, Utah State University Cooperative Extension, Table 2

7 IBID, Table 3

**Table 4-2
Magna WWTP Effluent Nitrogen Quantities**

Nitrogen Compound	Available Fraction (%)	Average Concentration (mg/L)	Equivalent pounds per Million Gallons of Effluent (lb./ 1 MG)
TKN	--	2.5	
Ammonium N	50%	1.4	5.8
Organic N (TKN - NH ₃)	30%	1.1	2.8
Nitrate +Nitrite	100%	9.6	80.1
Total			88.7

The Magna WWTP produces approximately 88.7 pounds of available nitrogen per million gallons treated. Approximately 2.3 MG of effluent water would need to be applied per acre of turf grass to meet the recommended nitrogen application rate for northern Utah turf grasses of 200 pounds of per acre per year. 2.3 MG of water is equivalent to 7.1 acre-feet of effluent water per acre of grass. As discussed in subsequent sections, this application rate greatly exceeds the water demand for turf grass which indicates the agronomic nutrient uptake requirements for turf grass will not be the controlling factor in determining the application rate.

4.2.2 Irrigation Water Requirements

Watering requirements for turf grass are highly dependent on temperature, wind, and relative humidity. The growing season in northern Utah is typically from early April through mid-October, an approximate seven-month period. Over the course of a growing season, a typical lawn will require two to four feet of water to maintain healthy growth. For this report it is estimated that 3.0 feet of water will be applied annually.

Lawns require less water in the cooler spring and fall months but may require as much as 2.0 to 2.5 inches per week of water during hot summer months. Figure 4-1 summarizes the recommended weekly application rate for turf grass throughout the summer growing season. This application rate was originally based upon the Turf Grass Watering Schedule as recommended by the Utah State University Extension Office and was adjusted slightly for a total annual application of 3 feet of water. A peak application rate of 2.25 inches per week is assumed for late July and early August.

**Figure 4-1
Recommended Watering Rate for Turf Grass**

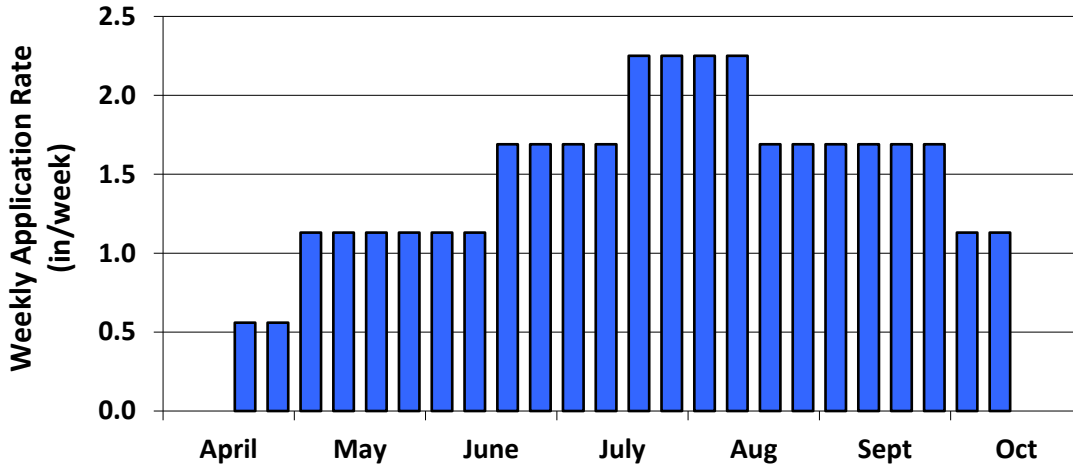

4.2.3 Application Limitations

As discussed in Section 4.2, it would take 7.1 feet of treated reuse water applied per square foot of grass to meet the nitrogen requirements of turf grass, and watering requirements for turf grass in northern Utah are estimated at 3.0 feet annually. A comparison of water quantities applied based on nutrient requirements versus water requirements is shown in Figure 4-2. Nearly 2.5 times the amount of water needed would have to be applied to meet the nutrient requirements of the turf grass; therefore the volume of water needed to meet the watering requirement will be the controlling factor when determining the acreage that can be irrigated with the Magna WWTP effluent.

**Figure 4-2
Effluent Land Application Limitations**

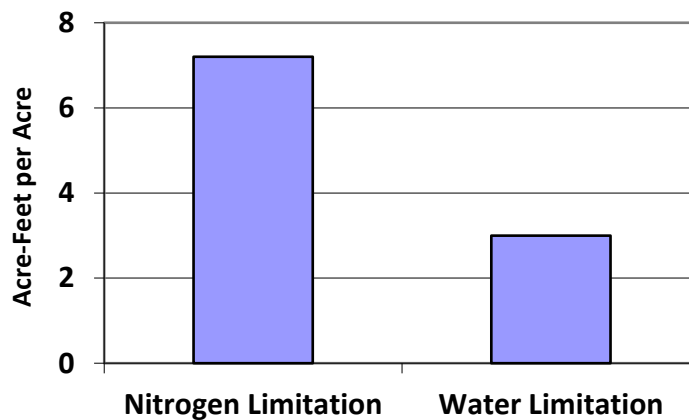

4.3 OPERATION AND MANAGEMENT PLAN

Type I Reuse water will be one of several sources that can be used within the District's secondary irrigation system. District secondary irrigation sources include shallow groundwater wells, Utah and Salt Lake Canal water, and the proposed Type I reuse water from the Magna WWTP. All three sources are needed to meet future water demands. The District will manage use of each source to maximize their respective beneficial uses. It is estimated that Type I reuse will be the primary source for the secondary irrigation system. The District has filed for and received Water Right 59-1004 which granted the right to use treated effluent leaving the WWTP. A copy of the water right is included in the Appendix.

The District will utilize the existing secondary irrigation distribution system to convey Type I reuse water to the end point of use. A majority of the secondary irrigation demand is for irrigation of residential landscaping, with some flows used for irrigation of public parks. The existing secondary irrigation system is physically disconnected from the potable water system and complies with the State of Utah cross connection rules. District construction standards require all new secondary irrigation piping to be clearly marked as designated for secondary use. Pipes can be marked using purple pipe, purple warning tape, and/or purple pipe wrap. New secondary irrigation distribution system pipelines will be constructed in accordance with R317-3-11.8 including separation, identification, and other requirements. The District's construction standards have been adopted and enforced for many years, therefore it is believed that a majority of the existing secondary distribution system meets the requirements identified in R317-11.8.

Warning labels will be installed on District owned facilities where the public may have access to secondary water such as public accessible hose bibbs and other access points. Warning signs will also be placed on the perimeter of the secondary irrigation storage pond restricting public access and indicating that the water is unsafe to drink.

It is estimated that the Reuse Facility will be utilized during the irrigation season (Apr.-Oct.). Significant maintenance of the equipment will be completed during the winter months. Other regular maintenance will be completed as necessary and per manufacturer recommendations. Design of the reuse facility will allow for a filter unit to be taken off-line for routine maintenance while continuing to treat reduced flows. Operation and maintenance will be completed by existing Magna WWTP staff. It is estimated that the Reuse Facility operating at start up flows will require an equivalent of 0.25 full time employees to operate and maintain during the summer months.

4.4 CONTINGENCY PLAN

The District has the ability to discharge treated effluent to the C-7 Ditch under their existing UPDES discharge permit. Treated effluent during the non-irrigation season will continue to be discharged to the C-7 Ditch. Discharge to the C-7 Ditch will also serve as the contingency plan in case of significant upset or failure in/of the reuse facility. Design of the filtration system and pump station will include redundant equipment with isolation measures to minimize the potential of complete operational disruptions. It is also noted that the Reuse Facility will have continuous on-line monitoring to confirm that treated effluent meets Type I reuse requirements prior to entering the distribution system. The Reuse System will shut down if the reuse water does not meet the requirements of Type I reuse. Upon shut down the secondary treated effluent will discharge to the C-7 Ditch with passive flow diversions.

As discussed previously, the District has three sources of water for the secondary irrigation system including shallow groundwater wells, Utah and Salt Lake Canal water, and the proposed Type I reuse.

The shallow ground water wells and canal water will be used to meet irrigation demands in the event that the Reuse Facility is shut down during irrigation system.

4.5 PUBLIC NOTIFICATION

Upon UDWQ approval of this Reuse Plan and prior to implementation, the District will notify all secondary irrigation users that Type I reuse water will be the preferred water source for the District's secondary irrigation system. Notice will be provided via an informational flyer to be included with the monthly bill sent to all District costumers, as well as an electronic notification for those that receive electronic invoices. Notices will be provided for two consecutive months and delivered at least 3 months prior to implementation. The notice will also be publicly posted on the District website. Notices will provide a short summary of the need for the project, summarize water quality of reuse water, remind users that secondary water is not to be consumed, identify approved uses of secondary water. The District will also advertise for and hold a public hearing for residents to express concerns.

A copy of this report and informational flyer also will be provided to the Salt Lake County Health Department.

4.6 CONCLUSIONS AND RECOMMENDATIONS

Major conclusions and recommendations contained in this section are summarized as follows:

1. Based upon effluent quality from Magna WWTP, nitrogen demand for turf grass greatly exceeds the water demand for turf grass which indicates the agronomic nutrient uptake requirements for turf grass will not be the controlling factor in determining the application rate.
2. The District has filed for and received Water Right 59-1004 which granted the District right to use the treated effluent leaving the WWTP.
3. Design of the reuse facility will allow for a filter unit to be taken off-line for routine maintenance while continuing to treat reduced flows. Operation and maintenance will be completed by existing Magna WWTP staff. It is estimated that the Reuse Facility operating at start up flows will require an equivalent of 0.25 full time employees to operate and maintain during the summer months.
4. The District has three sources of water for the secondary irrigation system, including shallow groundwater wells, Utah and Salt Lake Canal water, and the proposed Type I reuse. The shallow ground water wells and canal water will be used to meet irrigation demands in the event that the Reuse Facility is shut down during irrigation system.
5. Upon UDWQ approval of this Reuse Plan and prior to implementation, the District will notify all secondary irrigation users that Type I reuse water will be the preferred water source for the District's secondary irrigation system.

SECTION 5 – IMPLEMENTATION PLAN

5.1 CONSTRUCTABILITY REVIEW

It is proposed that the Reuse Facility be constructed on the eastern portion of the Magna WWTP property, just north of the existing BIOBROx Facility. See Figure 3-18 for the proposed location. It is estimated that the facility will be approximately 71 ft long by 31 feet wide with an estimated construction depth of 20 ft. below existing grade. It is expected that ground water will be encountered during construction. Similar construction activities on the Magna WWTP site have proven that ground water can be mitigated and controlled with proper construction dewatering methods. It is recommended that a geotechnical boring and investigation be completed for the proposed location. Based upon review of available drawings and site investigation, there are no known utilities within the proposed location that would prevent construction.

A diversion manhole will be constructed on the existing effluent pipeline that runs from the existing chlorine contact chambers to the existing effluent filter box. The purpose of the new diversion manhole will be to hydraulically connect the Reuse Facility allowing for passive diversion as discussed in Section 3. It is judged that the new diversion box could be constructed around the existing effluent pipeline while flows are discharged via the existing effluent box. Effluent flows within the effluent pipe would need to be diverted for several hours to cut and remove the existing pipe within the constructed box. Flows also could be diverted via bypass pumping or stopped by holding flows within the treatment processes. These options require prior planning and coordination with operations staff.

The District is currently constructing an extension to the secondary distribution system (Project SD-12) that will fully connect the WWTP to the rest of the existing secondary distribution system. This project is expected to be completed in the fall of 2021. Completion will allow conveyance of up to 3.0 mgd (2,100 gpm) of reuse water into the existing distribution system. Based upon current growth projections, it is expected that the existing system will be adequate to convey all reuse water through the year 2027. Once the reuse production exceeds 3.0 mgd (2,100 gpm), Projects SD-1 and SD-2 as identified in the secondary conveyance master plan will be needed so that pressures within the system do not exceed 150 psi. Once these projects are completed, the system should be capable of conveying all available reuse water through at least 2040.

5.2 ELECTRICAL CAPACITY EVALUATION

Electrical power requirements for reuse were determined by identifying the equipment required for the tertiary filtration recommendation (2+0 configuration) and summing up both the total connected and active power loads. Table 5-1 provides a summary of the electrical evaluation and shows the estimated power demand at buildout (4.65 MGD) at 586 kilovolt-amperes (kVA) or 705 amperes (A) of 480-volt (V) three phase power. At start-up the facility power demand is estimated at 422 KVA or 507A of 480V, three-phase power.

**Table 5-1
Electrical Power Requirements**

System	Equipment	Duty	Standby	Unit	VA	Total VA	Unit Load
Disinfection	Isolation Valves, Electric Actuator	4	0	-	500	2,000	
Filters	Drive Motors	2	0	hp	2,710	5,420	2
Filters	Backwash Pump	1	1	hp	16,737	16,737	15
Filters	Chemical Feed Pumps - Polymer	1	1	hp	1,674	1,674	1
Filters	Sump Pumps	2	2	hp	1,674	3,347	1
Filters	Pressure Transducers	2	0	-	500	1,000	
Filters	Vacuum Gauge with Transmitters	2	0	-	500	1,000	
Filters	Float Switches	2	0	-	500	1,000	
Filters	Ultrasonic Level Measurement	2	0	-	500	1,000	
Filters	Control Panels	2	0	-	500	1,000	
Filters	Analyzer - Turbidity	5	0	-	500	2,500	
Filters	Backwash Supply Control Valve, Electric Actuator	6	0	-	500	3,000	
Filters	Backwash Waste Control Valves, Electric Actuator	4	0	-	500	2,000	
Filters	Isolation Valves, Electric Actuator	4	0	-	500	2,000	
Filters	Exterior Systems (Lights, outlets, etc.)	1	0	-	500	500	
Reuse PS	NPS Isolation Valves, Electric Actuator	5	0		500	2,500	
Reuse PS	Reuse Pumps, Large	2	1	hp	191,280	382,560	200
Reuse PS	Reuse Pumps, Small	0	1	hp	61,369	0	60
Reuse PS	Electric Resistance Heater	1	0	-	1,500	1,500	
Reuse PS	Reuse Pump Isolation Valves, Electric Actuator	8	0	-	500	4,000	
Reuse PS	Control Panel	1	0	-	500	500	
Reuse PS	Analyzer - Chlorine	1	0	-	500	500	
Reuse PS	Building Systems (Lighting, outlets, etc.)	1	0	-	75,000	75,000	
Reuse PS	Building Systems (HVAC)	1	0	-	75,000	75,000	

KVA 585.7
AMPS AT 480V/3P 704.8

There are currently three existing power services for the MWD wastewater treatment facility that are listed here in the order of age: 1) at the old administration building; 2) at the BIOBROx building; and, 3) near the new lab/chemical storage building. An evaluation of each of these services for capacity sufficient to power the new reuse equipment loads resulted in the determination that only the new/lab chemical storage building service has potential capacity. Record drawings indicate the newer service includes a 1202A at 480V utility transformer and 3,200A, 480V rated service equipment (i.e. switchgear). The switchgear currently has a 1,000A breaker feeding the aeration

system and has room available for two additional breakers. Adding the reuse facility loads to this service requires at a minimum a new utility transformer, new conduits and conductors between the transformer and existing 3200A switchgear, and addition of another breaker section to the switchgear. This requires a shutdown and a temporary power supply for the aeration system. The duration of the shutdown is subject to coordination with the utility and availability of materials. It may be more efficient and less impactful to existing operations to add a new power service for the reuse facility. For conceptual planning and cost estimating it is assumed that a new power service is added for the reuse facility.

5.3 OPINION OF PROBABLE COSTS

Cost estimates are characterized based on the how far the project has progressed through the design phase. A cost estimate associated with a preliminary engineering design effort could be considered a Class 3 estimate in accordance with the American Association of Cost Engineers (AACE) with a project design being 10-40% complete. This classification and methodology are consistent with an index range of approximately +30/-20%. Where possible, budgetary costs for process specific equipment have been combined with current industry standards for industrial/municipal building projects in developing project costs.

Estimates of probable construction costs have been developed for each of the main project components discussed in the report. A summary of the estimates is show in Table 5-2. The projected level of accuracy as described above is 80-130% of the anticipated average bid price.

The following probable project cost opinion was prepared on the basis of information available at time of this report and our team experience and opinions and represents our judgment as qualified professional engineers. However, since we have no control over the cost of labor, materials, equipment, or services furnished by others, or over contractor(s)' methods of determining prices, or over competitive bidding or market conditions, we cannot guarantee that proposals, bids or actual project or construction cost will not vary from this opinion of probable cost. It is noted that there have been significant increases in construction costs within Utah. The cost estimate below includes a 20% increase based upon current construction market conditions.

**Table 5-2
Reuse Facility Opinion of Probable Cost**

Item	Description	Cost
1	General Conditions	\$ 400,000
2	Site Work (Excavation, Backfill, Grading, Paving)	\$ 250,000
3	Yard Piping	\$ 400,000
4	Structural (filter bay, wet well, building)	\$ 1,900,000
5	Filter Equipment Installed	\$ 900,000
6	Vertical Turbine Pumps and Piping Installed	\$ 500,000
7	Disinfection Improvements	\$ 100,000
8	HVAC	\$ 150,000
9	Building Electrical and I&C	\$ 700,000
10	Power Supply and Back Up Generation	\$ 800,000
11	Contingency (20%)	\$ 1,160,000
12	Subtotal	\$ 7,320,000

Item	Description	Cost
13	Contractor Overhead and Profit (18%)	\$ 1,317,000
14	Current Bidding Market (20%)	\$ 1,464,000
15	Total Construction Costs	\$ 10,102,000
16	Administration and Engineering (18%)	\$ 1,818,000
17	Project Total	\$ 11,920,000

5.4 FUNDING ALTERNATIVES

The District has been awarded a \$4,925,000 grant as part of the WaterSMART Program. This funding is part of the United States Bureau of Reclamation (USBR) Title XVI Water Reclamation and Reuse Program. A portion of the grant money will be set aside for USBR to ensure the project's Federal and statutory compliance, and to otherwise oversee implementation of the project. This allocation is estimated at \$200,000. Therefore, approximately \$4.7 million will be available for planning, administration, engineering and construction of the approved reuse project. The following outlines some additional sources that may be considered for financing the remaining portion of project costs.

Utah State Revolving Loan Program: The Utah Clean Water State Revolving Fund (SRF) was established pursuant to Title VI of the Federal Clean Water Act of 1987. The SRF provides low interest rate loans for funding water quality and wastewater infrastructure projects in Utah. The State of Utah receives Capitalization Grants from the Environmental Protection Agency (EPA) and provides 20% state matching funds for awarded grants. UDWQ and the Utah Department of Water Resources operate a state loan program which provides an alternative source of funding for certain water quality projects. The state loan program provides additional flexibility for project development without some of the funding conditions or restrictions that accompany the SRF funds. It is likely that the Reuse Facility could receive a low interest loan from the SRF Program. It is unlikely that UDWQ or UDWR would provide grant money towards the reuse project.

American Rescue Plan Act of 2021 (ARPA): The ARPA is a \$1.9 trillion coronavirus rescue package designed to facilitate United States recovery from economic and health effects of the COVID 19 pandemic. As part of the overall package, \$365 billion has been earmarked for direct funding to state and local government for infrastructure projects improving transportation, water, sewer and broadband networks. These funds will remain available until 2024 or until fully utilized. A fact sheet summarizing the ARPA is included in the appendices. Due to newness of this program, specific project requirements and the application process are still being finalized. However, it is our understanding that Salt Lake County and Magna Township have been granted funding to complete shovel ready infrastructure projects within their service areas. It is recommended that MWD further investigate ARPA funding opportunities for this project.

EPA Water Infrastructure Finance and Innovation Act (WIFIA): WIFIA was established in 2014 to provide long-term, low-cost supplemental loans for regional nationally significant projects. The maximum portion of eligible project costs that WIFIA can fund is 49%, with a minimum loan amount of \$5.0 million. Interest rate is equal or greater than US Treasury rate of similar maturity. The Reuse Facility may qualify for the WIFIA loan program; however, the WIFIA program is intended for much larger projects, and the requirements for funding may be more difficult than the State SRF funding.

Private Municipal Bond: Municipal bonds allow governmental agencies borrow money to fund large projects. General obligation municipal bonds are backed by the entities overall

creditworthiness and the ability to generate revenue through rates and/or by levying taxes. Interest rates on the private municipal bond market are usually a little higher than the private bond market; however, there are fewer regulations and stipulations associated with bond loans.

5.5 IMPLEMENTATION SCHEDULE

In 2019, the District applied for and was granted a variance to the recently implemented Technology Based Phosphorus Effluent Limit (TBPEL). This variance granted the District an interim effluent total phosphorus limit of 1.8 mg/L until January 1, 2025. After January 1, 2025, the phosphorus limit will drop to 1.0 mg/L. As part of the variance, MWD agreed to add chemical treatment for phosphorus removal, which has been completed. The District also agreed to move forward with the Reuse Project, submitting construction plans to UDWQ by July 1, 2022 with the facility to be in operation no later than January 1, 2025.

The schedule below identifies project milestones to meet requirements of the UDWQ variance. Adherence to the schedule meets the UDWQ requirements and also allows the reuse facility to be operational prior to the 2024 irrigation season. Operating the reuse facility during the 2024 irrigation season will allow MWD to optimize the facility and provide valuable information to assist in navigating the 2025 phosphorus permit requirements.

**Table 5-3
MWD Reuse Facility Implementation Schedule**

Task	Length	2021				2022				2023				2024				2025	
		Q1	Q2	Q3	Q4	Q1	Q2	Q3	Q4	Q1	Q2	Q3	Q4	Q1	Q2	Q3	Q4	Q1	
Reuse Plan Development	6-months	█	█	█															
Reuse Plan Submitted to DWQ				◆															
Final Design	9-Months			█	█	█	█	█											
Design Submitted to DWQ	July 1, 2022							◆											
Bid Period and Award	3-months							█	█	█									
Construction	18-Months							█	█	█	█	█	█	█	█	█	█	█	█
Start Up and Testing	1.5 Months																	█	█
Optimization	3-Months																	█	█
Operational DWQ Requirement	January 1, 2025																		◆

2024 IRRIGATION SEASON

5.6 CONCLUSIONS AND RECOMMENDATIONS

Major conclusions and recommendations contained in this section are summarized as follows:

1. There are no known significant constructability concerns with the proposed reuse facility. Proper construction planning and methods can accommodate estimated ground water conditions and system tie-ins.
2. The new facility will require significant improvements/additions to the WWTP electrical power system. The existing back up generation system does not have capacity for the additional load from the reuse pump station.
3. The District has been awarded a \$4,925,000 grant as part of the WaterSMART Program. This funding is part of the United States Bureau of Reclamation (USBR) Title XVI Water Reclamation and Reuse Program. It is recommended that MWD further investigate ARPA funding opportunities.
4. An existing variance with UDWQ requires MWD to submit construction plans for the Reuse Project by July 1, 2022 with the facility in operation no later than January 1, 2025. This schedule is achievable; however, it is important that the final design process begin as soon as possible.



BOWEN COLLINS
& A S S O C I A T E S

www.bowencollins.com

Salt Lake Area Office:

154 East 14075 South
Draper, Utah 84020
Phone: (801) 495-2224
Fax: (801) 495-2225

Ogden Office:

2036 Lincoln Ave, Ste. 104
Ogden, Utah 84401
Phone: (801) 495-2224
Fax: (801) 495-2225

Southern Utah Area Office:

20 North Main Street
Suite 107
St. George, Utah 84770
Phone: (435) 656-3299
Fax: (435) 656-2190

Boise Area Office:

776 East Riverside Drive
Suite 250
Eagle, Idaho 83616
Phone: (208) 939-9561
Fax: (208) 939-9571